

Environmental Assessment Worksheet (EAW)

Spirit Mountain Recreation Area

Prepared for
City of Duluth

May 2016



Environmental Assessment Worksheet (EAW)

Spirit Mountain Recreation Area

Prepared for
City of Duluth

May 2016

Spirit Mountain Recreation Area EAW

May 2016

Contents

Environmental Assessment Worksheet.....	3
1. Project Title	3
2. Proposer	3
3. RGU	3
4. Reason for EAW Preparation	4
5. Project Location	4
6. Description	4
7. Cover Types	14
8. Permits and Approvals Required.....	15
9. Land Use	16
10. Geology, Soils and Topography/Land Forms.....	19
11. Water Resources	21
12. Contamination/Hazardous Materials/Waste.....	27
13. Fish, Wildlife, Plant Communities, and Sensitive Ecological Resources (Rare Features)	28
14. Historic Properties.....	33
15. Visual	34
16. Air	34
17. Noise.....	35
18. Transportation	36
19. Cumulative Potential Effects	38
20. Other Potential Environmental Effects.....	39

List of Tables

Table 5-1	Sections Crossed by Proposed Recreational Improvements	4
Table 6-1	Magnitude of proposed project components	10
Table 6-2	Mountain Bike Trail Specifications	11
Table 6-3	Environmental review and timeline for past developments	14
Table 7-1	Cover types for proposed project components (acres)	14
Table 8-1	Permits and Approvals Required	15
Table 10-1	Maximum dimensions of project components	21
Table 11-1	Number of existing and proposed waterway crossings	22
Table 11-2	MPCA 303d Impaired Waters List of surface waters within 1 mile.....	22
Table 11-3	Off-site well locations.....	23
Table 13-1	Habitat Changes by Cover Types.....	31
Table 18-1	Estimated Existing Parking Spaces at Spirit Mountain.....	36

List of Figures

Figure 1	Project Overview Map
Figure 2	Nordic Ski Trails Aerial Map
Figure 3	Mountain Bike Trails Aerial Map
Figure 4	Hiking Trails Aerial Map
Figure 5	Rail-to-Trail Aerial Map
Figure 6	Disc Golf Aerial Map
Figure 7	Forest Cover Types Map
Figure 8	Shoreland Areas Map
Figure 9	NRCS Soils and Hydric Rating Map
Figure 10	Floodplain Map
Figure 11	Wetlands Map

List of Appendices, Attachments, or Exhibits

Appendix A	State Historic Preservation Officer (SHPO) Determination
Appendix B	Typical Trail Designs
Appendix C	Lower Nordic Ski Trail Lighting Information
Appendix D	Lower Nordic Ski Trail Snow Making Noise Analysis
Appendix E	Bessemer Street Drainage Analysis

Environmental Assessment Worksheet

July 2013 Version

This Environmental Assessment Worksheet (EAW) form and EAW Guidelines are available at the Environmental Quality Board's website at:

<http://www.eqb.state.mn.us/EnvRevGuidanceDocuments.htm>. The EAW form provides information about a project that may have the potential for significant environmental effects. The EAW Guidelines provide additional detail and resources for completing the EAW form.

Cumulative potential effects can either be addressed under each applicable EAW Item, or can be addresses collectively under EAW Item 19.

Note to reviewers: Comments must be submitted to the RGU during the 30-day comment period following notice of the EAW in the *EQB Monitor*. Comments should address the accuracy and completeness of information, potential impacts that warrant further investigation and the need for an EIS.

1. Project Title

2016-2017 Spirit Mountain Recreation Area Improvements, Duluth, Minnesota

2. Proposer

City of Duluth, Minnesota

Contact person: Jim Shoberg

Title: Project Coordinator

Address: 411 West First Street – Ground Floor

City, state, ZIP: Duluth, Minnesota 55802

Phone: (218) 730-4316

Email: jshoberg@duluthmn.gov

3. RGU

City of Duluth, Minnesota

Contact person: Keith Hamre

Title: Director of Planning and Construction Services

Address: 411 West First Street – Room 208

City, state, ZIP: Duluth, Minnesota 55802

Phone: (218) 730-5580

Fax: (218) 730-5901

Email: khamre@duluthmn.gov

4. Reason for EAW Preparation

EIS scoping **Mandatory EAW** Citizen petition RGU discretion Proposer volunteered

If EAW or EIS is mandatory give EQB rule category subpart number(s) and name(s): [Minn. Rules 4410.4300 Subp37A. Recreation Trails](#); EAW required to construct trails on forested land that will exceed ten miles in total on Spirit Mountain property.

5. Project Location

County: [St. Louis County](#) City/Township: [City of Duluth](#)

Table 5-1 Sections Crossed by Proposed Recreational Improvements

Township	Range	Section
49	15	14
49	15	15
49	15	22
49	15	23

6. Description

- a. Provide a brief project summary to be published in the *EQB Monitor*, (approximately 50 words).
The Spirit Mountain recreational improvements include construction and maintenance of Nordic cross country ski trails (5.8 kilometers/3.6 miles), construction of mountain bike trails (10.0 miles), Superior Hiking Trail extensions (1.5 miles), Rail-to-Trail conversion (0.8 miles), and a disc golf course (18 holes, approximately 1.5 miles).

- b. Give a complete description of the proposed project and related new construction, including infrastructure needs. If the project is an expansion include a description of the existing facility. Emphasize: 1) construction, operation methods and features that will cause physical manipulation of the environment or will produce wastes, 2) modifications to existing equipment or industrial processes, 3) significant demolition, removal or remodeling of existing structures, and 4) timing and duration of construction activities.

The proposed recreational improvements include five main components within or directly adjacent to the Spirit Mountain Recreation Area: 1) Nordic cross country ski trails, 2) mountain bike trails, 3) Superior Hiking Trail extensions, 4) Rail-to-Trail conversion, and 5) a disc golf course. Several project components have multiple trail types or locations within the project site, which are shown on Figure 1 and described below. The length and area of each proposed component are listed in Table 6-1.

The Spirit Mountain Recreation Area is a regional destination for alpine skiing, snowboarding, Nordic skiing, mountain biking, hiking, bird watching as well as a local destination for wedding

receptions, and other large meeting events. Spirit Mountain primarily serves the Duluth-Superior and surrounding communities, and regularly receives visitors from Minnesota and Wisconsin.

The proposed trail alignments and associated impacts identified in the figures and discussed in the EAW are based on preliminary site evaluations; final locations will be field fit and confirmed as each project component goes into the final design and construction phase. Boardwalks, bridges, and/or culverts will be used in locations where the proposed trails cross waterways or wetland areas. All proposed bridges will be 3 to 4 feet wide and constructed of treated lumber or other rot resistant natural wood. As shown in Appendix B, each new bridge will span the waterway (tethered at one end) without the need for piers or excavation below the ordinary high water level (OHWL).

The proposed trails will be built to International Mountain Bike Association (IMBA) sustainable trail guidelines and/or the Minnesota Department of Natural Resources (MNDNR) trail planning, design, and development guidelines, as appropriate. Sustainable trails are based on incorporating three principals into the design:

- Trails which are designed to retain their form over years of use and natural forces acting on them;
- Trails which are designed to minimize ecological impacts, especially in sensitive areas; and
- Trails which are designed to foster a sense of individual responsibility for stewardship.

The City of Duluth will hire design consultants and construction contractors that build trails to these guidelines to minimize ecological impacts, reduce maintenance and prevent erosion problems. The proposed recreational improvements will be completed in phases based on funding availability and sources. Construction is proposed to begin in 2016 and will be completed in 2017 depending on available funding.

i. **Nordic cross country ski trails** – lower, upper, and connector trails (see Figure 2)

The Nordic ski trails will be accessible for use during winter months and will be restricted to only dry trail use in the summer months to reduce the potential for soil compaction. Potential summer uses may include hiking or occasional planned special events, such as mountain biking and equestrian use. Summer maintenance activities, such as mowing, will keep woody plant growth under control.

Lower Nordic ski trails: Approximately 3.2 kilometers (approximately 2.0 miles) of new cross country ski trails are proposed at the base of Spirit Mountain and will include lighting, snowmaking capabilities, and a staging area.

The proposed trails will be cleared and grubbed, and then graded with a dozer to a corridor width of 9 meters (approximately 30 feet) that will allow use by classic and skate skiers. Culverted crossings of streams will require an excavator and dozer to complete the trail system. Culverts will be installed on some parts of the upper trail system as well as the lower Nordic trail system. The construction of these trails and culvert installations will require permitting. This

wider width will allow for initial construction activities, for proper snow making conditions, for enhanced skier experience (to allow skiers of different abilities an opportunity to safely pass), and for hosting higher level (revenue generating) events that require a 9 meter width.

Light poles (approximately 4-6 feet tall) will be placed approximately every 150 feet along the trail corridor (see Appendix C). The lighting will be designed to maintain adequate light levels on the trails while reducing light pollution by using down-cast lighting that is dark-sky compliant with additional shielding on the sides facing residential homes.

The lower Nordic trails will originate from a new staging area located southwest of Warwick Street and will provide multiple loops that will cross the existing DWP railroad grade in two locations. The proposed staging area will be approximately 100 meters long and 36 meters wide (approximately 328 feet by 118 feet) in order to provide a start and finish area for race events as well as serve as a flatter area for ski lessons. The proposed lower Nordic trails will cross 84th Ave W Creek in two locations and 85th Ave W Creek in four locations. Culverts will be used at these six stream crossings to allow for safe passage of skiers and snow grooming equipment. Each culvert will be approximately 30 to 40 feet long and adequately sized to handle the required flow that will include additional man-made snow from the alpine and Nordic operations. The culverts will be designed and constructed following MNDNR Best Management Practices (BMPs).

Approximately 2 miles of water pipeline will be installed within the Nordic trail corridor. A trench approximately 2 to 3 feet wide will be required to install the water pipeline that will be backfilled to match the surrounding trail grade. Snowmaking equipment (44 units) will be installed directly adjacent to the trail corridor at 50 to 500 foot intervals to ensure consistent snow conditions throughout the winter recreation season (see Appendix D).

A portion of the southernmost loop of the lower Nordic ski trails will be constructed on private property through an easement.

Upper Nordic ski trails: Maintenance and trail alignment modifications are proposed at the existing Nordic ski trails located at the top of Spirit Mountain.

Two new segments of 7 meters (approximately 23 feet) wide trail are proposed to the existing upper Nordic ski trails (approximately 0.6 kilometers/0.4 miles). One segment will re-route the trail alignment outside of a seasonally wet location that has presented ongoing maintenance problems. This wet trail segment (approximately 0.2 kilometers/0.1 miles) will be closed, restored and removed from the upper Nordic trail system. The second proposed segment will be constructed to allow for a one-way directional system by creating a loop of the existing trail alignment.

New culverts are proposed in six locations to correct drainage problems and prevent icing of the existing upper Nordic ski trails. The culverts will be designed to handle adequate flow rates and will follow MNDNR BMPs.

Connector Nordic ski trail: Approximately 1.9 kilometers (approximately 1.2 miles) of new trail is proposed to connect the lower and upper Nordic ski trails. The proposed connector trail will also be built to a corridor width of 7 meters (approximately 23 feet) that will allow use by classic and skate skiers. This trail will cross Gogebic Creek in three locations and 85th Ave W Creek in one location. Culverts will be used at each stream crossing to allow for safe passage of skiers and snow grooming equipment. Each culvert will be approximately 30 to 40 feet long and adequately sized to handle the required flow that will include additional man-made snow from the alpine and Nordic operations. The culverts will be designed and constructed following MNDNR BMPs. Regulatory permits will be obtained.

- ii. **Mountain bike trails** – cross country, downhill, and Duluth Traverse trails (see Figure 3)
Similar to the Duluth Traverse multi-use single-track trail system, the proposed mountain bike trails at Spirit Mountain will be designed and built to IMBA sustainable trail guidelines (see Table 6-2 for Trail specifications). Trails built to IMBA guidelines have been built throughout Duluth, as well as hundreds of locations throughout the United States. The trails built to these guidelines have proven themselves to be sustainable. Examples of IMBA Sustainable Trail building Guidelines to be implemented in the design and construction of this project include:

Avoid the Fall Line – Fall-line trails usually follow the shortest route down a hill – the same path that water flows. The problem with fall-line trails is that they focus water down their length. The speeding water strips the trail of soil; exposing roots, creating gullies and scarring the environment.

Avoid Flat Areas – Trails that are not located on a slope have the potential for the trail to become a collection basin for water leading to chronically muddy conditions. The trail tread must always be slightly higher than the ground on at least one side of it so that water can drain properly.

Slope the trail tread - Outslope encourages water to sheet across and off the trail, instead of funneling down the center. Insloping the trail's tread to sump areas also keeps water from funneling down the center of the trail.

Follow the Half Rule - The trail grade should not exceed half the grade of the hillside or sideslope that the trail traverses to prevent it from becoming a fall line trail.

Maintain an average trail grade of 10% or less for the majority of the trails – An average grade of 10% or less is most sustainable to prevent erosion.

Establish and don't exceed the Maximum Sustainable Trail Grades except for very short distance and other special sustainable conditions (typically 15-25%).

Implement Rolling Contour Trails with Grade Reversals – Grade reversals force water to exit the

trail at the low point before it can gain more volume and momentum and erosive power.

All-weather cross country bike trails: In areas of poor soil, the all-weather section of the cross country bike trail will include a three inch minus angular blast rock base that will be capped with a 3/8 inch minus crushed fine aggregate. The all-weather trail will be designed and purpose built for mountain biking; however, the trail could also be multi-use and suitable for a variety of other human-powered uses such as trail running, hiking, dog-walking, bird watching, cross country skiing and/or snowshoeing.

The proposed trails will be constructed with small equipment such as a mini-excavator or mini-skid steer and hand tools. The proposed corridor width for the all-weather trails will be 3 to 4 feet wide. The proposed trail alignment will use an existing bridge to cross Knowlton Creek and will require an additional new bridge to cross 82nd W Creek.

Natural surface cross country bike trails: The natural surface section of the cross country trail will be owned and operated by Spirit Mountain Recreation Area and will be built on the native mineral soils after removing the organic topsoil layer. Initially this proposed section of trail will be designated specifically for mountain bike users; however, in the future the use by other recreational users may be expanded.

The proposed trails will be constructed with small equipment such as a mini-excavator or mini-skid steer and hand tools. The proposed corridor width for the entire cross country bike trails will be 3 to 4 feet wide, which is anticipated to narrow over time to 18 to 24 inches as revegetation occurs. The proposed trail alignment will use two existing bridge crossings (one across Knowlton Creek and one across 84th Ave W Creek) and five new bridge crossings (one across Knowlton Creek, 85th W Ave Creek, and Lenroot Creek, and two across Gogebic Creek).

Downhill mountain bike trails: A proposed downhill zone (as shown in Figure 3), will include approximately ten new downhill trails that will range from beginner to advanced. The proposed downhill trail alignments will be machine built on the native mineral soils and designed and built to IMBA sustainable trail guidelines to minimize maintenance and erosion problems. The constructed trail corridor width will initially be 4 feet wide, which is anticipated to narrow over time as revegetation occurs. The proposed trail alignments will cross Gogebic Creek in several locations requiring eight new bridges.

iii. **Superior Hiking Trail (SHT) extensions** – upper and lower spurs (see Figure 4)

Upper hiking trail spur: The proposed 0.9 mile upper trail alignment will connect the existing campground at the top of Spirit Mountain to the upper chalet and will be designed specifically for hiking use only. The trail will be constructed with small equipment such as a mini-excavator or mini-skid steer or with hand tools, and will have a 1 to 1.5 feet wide natural surface trail. There is one proposed stream crossing of Gogebic Creek.

Lower hiking trail spur: The proposed 0.6 mile lower trail alignment will connect the lower chalet to the existing Western Waterfront Trail. The spur will cross three existing trails or other infrastructure as follows: 1) an underpass bridge under Grand Avenue (to be constructed by the Minnesota Department of Transportation in 2016), 2) over the existing Willard Munger State Trail at the trail elevation, and 3) underneath the BNSF railroad bridge that spans Knowlton Creek. This proposed spur will be a multi-use trail that will be machine built with a 36 inch wide natural surface trail surface.

iv. Rail-to-Trail conversion of the DWP railroad grade

The Rail-to-Trail conversion will proceed west from the lower chalet to where the trail intersects Gogebic Street; approximately 0.8 miles to the west (see Figure 5). The existing track ballast of the DWP railroad grade will be capped at an approximate width of 10 feet with crushed fines or limestone to ensure ADA accessibility. Typical equipment may include a dozer, excavator and trucks to haul and place the material. The proposed lower Nordic ski trails will cross the DWP railroad grade in two locations to allow for the passage of skiers and snow grooming equipment. The crossing location closest to the lower chalet (approximately 800 feet west of the chalet), will require the elevation of the existing railroad grade to be lowered several feet. The second crossing, located approximately 1,450 feet west of the chalet, is closer to the existing grade of the proposed lower Nordic ski trail and will either be crossed at grade or possibly require a shallow dip in the DWP railroad grade. Each proposed crossing will be 30 feet wide and if the railroad grade is required to be lowered, a five percent grade will be maintained to ensure ADA compliance for the DWP Rail-to-Trail.

In the warmer months, potential trail users include human-powered recreational uses such as biking, running, hiking, dog-walking, and bird watching. During the snow season, the recreational users may include biking, Nordic skiing and snowshoeing.

v. Disc golf course

The existing 14-hole disc golf course was closed in the summer of 2015, with 10 holes being impacted by the construction of a water supply infrastructure and erosion control project that was installed for snowmaking. A new 18-hole course is proposed within the "Disc Golf Zone" that will be interspersed amongst the slopes and surrounding forest areas of the existing alpine downhill runs (see Figure 6). The course will be constructed by mowing existing vegetation and trails will be cleared and leveled between holes. Trees and brush will be selectively removed. Stumps will be cut flush with the ground; no grubbing of stumps or roots will take place.

There will be up to four basket placements per hole (located at both ends of each hole) to allow the course to be periodically reversed. This common practice of switching the direction of the "greens" and tee boxes provides greater variety to golfers and also minimizes the locations of higher temporary impact areas. Each hole will have a tee box constructed of paver stones (approximately four feet by nine feet), a trash can, a recycling bin, a fairway (approximately 40

feet wide and lengths varying from 125 to 600 feet), and a basket at the end of each hole (approximately 30 feet in diameter of unobstructed space at each "green"). It is not known at this time if there will be trails constructed to link holes together or if they will simply mow a path.

c. Project magnitude:

Table 6-1 below provides a description of total length of each of the five components of the project. Table 6-2 provides a detailed description of Mountain Bike Trail Specifications by degree of difficulty and trail type.

Table 6-1 Magnitude of proposed project components

Project Component	Anticipated Total Length and Area
Nordic cross country ski trails	Lower trails: approx. 3.2 kilometers (2.0 miles, 7.2 acres) Upper trails: approx. 0.6 kilometers (0.4 miles, 1.0 acres) Connector trail: approx. 1.9 kilometers (1.2 miles, 3.3 acres) <i>Total: approx. 5.8 kilometers (3.6 miles, 11.5 acres)</i>
Mountain bike trails	Natural surface trails: approx. 3.0 miles (1.8 acres) Downhill trails: approx. 4.6 miles (2.2 acres) All-weather trails: approx. 2.4 miles (1.1 acres) <i>Total: approx. 10.0 miles (4.8 acres)</i>
Superior Hiking Trail extensions	Upper spur: approx. 0.9 miles (0.2 acres) Lower spur: approx. 0.6 miles (0.2 acres) <i>Total: approx. 1.5 miles (0.4 acres)</i>
Rail-to-Trail conversion	Approx. 0.8 miles (1.0 acres)
Disc golf course	Approx. 1.5 miles (12.5 acres)

Table 6-2 Mountain Bike Trail Specifications

Label	Working title	Difficulty Rating	Symbol ¹	Use	Directional	Feature Frequency ²	Constructed Tread Width ^{3,4}	Ave Trail Grade per 1000'	Max Trail Grade: climbing ⁵	Max Trail Grade: descending ⁶	Min Turn Radius	Max Turnpad Grade ⁷	Max Berm/Turn Camber ⁸	Corridor Width (4' above tread)
Spec 1	Green Singletrack (Traditional bike optimized shared-use singletrack)	Easier	Green Circle	bike, foot	Two-Way	Low	48"	5%	20%	20%	10'	10%	15%	48"-72"
Spec 2	Blue Singletrack (Traditional bike-optimized singletrack)	More Difficult	Blue Square	bike, foot	Two-Way	Medium	36"	7%	25%	50% (armored over 25%)	8'	15%	30%	36"-72"
Spec 3	Black Singletrack (Traditional technical singletrack)	Most Difficult	Black Diamond	bike, foot	Preferred	High	18"	10%	50% (armored over 25%)	100% (armored over 25%)	6'	15%	50%	36"-48"
Spec 4	Green Bump Pump	Easier	Green Circle	bike, foot	Preferred	High	48"	3-5%	20%	30% (armor as function of flow)	15'	10%	30%	48-72"
Spec 5	Blue Bump Pump	More Difficult	Blue Square	bike, foot	Preferred	High	36"	7-10%	30%	100% (armor as function of flow)	10'	15%	50%	36"-72"
Spec 6	Black Bump Pump	Most Difficult	Black Diamond	bike	One-Way	High	36"	10-12%	n/a	150% (armor as function of flow)	7'	25%	150%	36"-72"
Spec 7	Green Jump	Easier	Green Circle	bike	One-Way	Medium	48"+	3-5%	n/a	30% (armor as function of flow)	20'	10%	150%	48-72"
Spec 8	Blue Jump	More Difficult	Orange Pill, medium	bike	One-Way	Low	48"+	7-10%	n/a	100% (armor as function of flow)	15'	15%	∞%	48-72"
Spec 9	Black Jump	Most Difficult	Orange Pill, large	bike	One-Way	Low	48"+	10-12%	n/a	150% (armor as function of flow)	15'	25%	∞%	48-72"
Spec 10	Green Gravity	Easier	Orange Pill, small	bike	One-way	Medium	48"	7-10%	n/a	100% (armor as function of flow)	20'	15%	150%	48-72"
Spec 11	Blue Gravity	More Difficult	Orange Pill, medium	bike	One-way	Medium	36"	10-15%	n/a	∞% (mandatory drops)	15'	25%	∞%	36"-72"
Spec 12	Black Gravity	Most Difficult	Orange Pill, large	bike	One-way	High	24"	15-20%	n/a	∞% (mandatory drops)	15'	25%	∞%	36"-72"
Spec 13	Gateway trail	Easiest	Green Circle	bike, foot, horse	Two-Way	Low	48"+	3-5%	10%	15%	12'		10%	
Spec 14	Accessible trail	Easiest		bike, foot, horse	Two-Way	None								

Table Footnotes

1. Orange Pill Symbol assumes trails inside controlled-access facilities, like a bike park or resort.
2. Feature Frequency is averaged over long distances. Per 100': "low" = 2-3 features, "med" = 3-5 features, "high" = 5-10 features.
3. Constructed tread width may narrow over short distances to 50% of spec. Examples include rock or tree gateways.
4. Tread width also applies to bridges and boardwalks. Check with local regulations for overriding guidelines on width or any other requirements (height restrictions, railings, etc.).
- 5 & 6. Max grades climbing and descending refer to extremely short segments, 10 feet or less.
7. Turnpad grade measures the rise/fall across the turning surface at the base of any inslope.

8. Max camber is measured at the top of the inslope. More advanced berms will go to "vertical".

9. Roughness attempts to capture average tread coarseness. Tread area with obstacles: "low" = less than 5%, "med" = less than 20%, "high" = over 20%, "very high" = over 50%.

General Notes

Trail specifications developed for the Duluth Traverse Trail System and will be incorporated into the mountain bike trail design as appropriate. Sustainable trails guidelines provide the foundation for all design + construction decisions ("half rule", frequent grade reversals, max grades function of soils + use, etc.).

All trails should have a minimum grade and camber (in/outslope) of 3% to ensure a well-drained tread.

Label	Corridor Height Minimum	Exposure (without railing)	Unavoidable Obstacles	Avoidable Obstacles (over 50% of tread or less)	Rollable Feature Height (jumps, berms, etc.)	Roughasity (surface texture) ⁹	Tread and trail features	Notes
Spec 1	10-12'	less the 36"	less than 2"	less than 6"	12"	low	Firm trail surface. May include rock armored section.	
Spec 2	8-12'	less than 48"	less than 8"	less than 24"	24"	med	Modest rough tread is expected. May include steps and terraces.	May include features similar to those on easier "Bump and Pump" or "Jump" trails.
Spec 3	8-12'	no limit	less than 18"	less than 48"	36"	high, some very high	Significant unavoidable obstacles are expected. May include steps, stairs, rock gardens, loose rock, and significantly exposed sections.	Seek out rocky ridges. Selective machine work to create very organic appearing rock strewn tread. Most rock and tread work
Spec 4	8-10'	less the 36"	less than 2"	less than 6"	12"	low	Firm trail surface. Rollers and berms. May include rock surfaced sections.	
Spec 5	10'-12'	less than 60"	less than 2"	less than 24"	24"	low	Firm trail surface. Rollers, roller doubles, berms predominate. May include significant armored sections.	Demonstration trail at Spirit Mountain is an example of the upper end of this spectrum.
Spec 6	10'-12'	less than 120"	less than 8"	less than 48"	36"	med	Firm trail surface. Rollers, roller doubles, berms predominate. May also include steps, stairs, rock gardens and exposed sections.	
Spec 7	10-12'	less the 36"	less than 2"	less than 6"	18"	low	Smooth continuously cambered trail surface. Easily rollable jumps.	A green jump trail could fit within a stacked-loop system. Blue and Black are likely best
Spec 8	12'-15'	less than 60"	less than 2"	less than 24"	30"	low	Smooth continuously cambered trail surface. May include significant armored sections. More complex jump configurations.	Complete berms, plan on extreme drainage solutions - sumps + culverts.
Spec 9	12'-15'	less than 120"	less than 8"	less than 48"	48"	med	Firm trail surface. May include rock surfaced sections. Some jumps may not be rollable.	Complete berms, plan on extreme drainage solutions - sumps + culverts.
Spec 10	12'	less the 36"	less than 18"	less than 24"	18"	high	Entry level downhill course. Will include rocks, steps, and terraces. Drops will be rollable.	For all DH types, potentially only at Spirit Mtn.
Spec 11	12'	less than 60"	less than 48"	n/a	30"	very high	Intermediate level downhill course. Mandatory drops. Will include significant steps, stairs, rock gardens and exposed sections.	
Spec 12	12'	less than 120"	less than 72"	n/a	48"	very high	Advanced level downhill course. Significant mandatory drops. Will include extreme terrain that has a high penalty for failure.	
Spec 13	10-12'							Very front-country, likely connected to a recreation park. Typically under a mile.
Spec 14								AASTHO spec trail.

Table Footnotes

1. Orange Pill Symbol assumes trails inside controlled-access facilities, like a bike park or resort.
2. Feature Frequency is averaged over long distances. Per 100': "low" = 2-3 features, "med" = 3-5 features, "high" = 5-10 features.
3. Constructed tread width may narrow over short distances to 50% of spec. Examples include rock or tree gateways.
4. Tread width also applies to bridges and boardwalks. Check with local regulations for overriding guidelines on width or any other requirements (height restrictions, railings, etc.).
- 5 & 6. Max grades climbing and descending refer to extremely short segments, 10 feet or less.
7. Turnpad grade measures the rise/fall across the turning surface at the base of any inslope.

8. Max camber is measured at the top of the inslope. More advanced berms will go to "vertical".

9. Roughasity attempts to capture average tread coarseness. Tread area with obstacles: "low" = less than 5%, "med" = less than 20%, "high" = over 20%, "very high" = over 50%.

General Notes

Trail specifications developed for the Duluth Traverse Trail System and will be incorporated into the mountain bike trail design as appropriate. Sustainable trails guidelines provide the foundation for all design + construction decisions ("half rule", frequent grade reversals, max grades function of soils + use, etc.).

All trails should have a minimum grade and camber (in/outslope) of 3% to ensure a well-drained tread.

- d. Explain the project purpose; if the project will be carried out by a governmental unit, explain the need for the project and identify its beneficiaries.

The overall purpose of the project is to expand and diversify the four-season recreational opportunities for Duluth residents and visitors from around the region. Collectively, the project will increase the connectivity between the St. Louis River (and the existing Western Waterfront Trail) through Spirit Mountain to existing trail systems such as the Superior Hiking Trail, the Duluth Traverse Trail, the Munger Trail, the Cross City Trail, and the DWP railroad grade in accordance with the 2008 Spirit Mountain Master Plan, the 2014 Spirit Mountain Mini Master Plan, and the 2015 Cross City Trail Mini Master Plan.

Additionally, the all-weather mountain bike trail will provide a unique type of trail that will be constructed to allow multi-use during wet-weather periods when other trails in Duluth (constructed on the native clay soils) are closed due to potential for rutting and other damage. This will make Duluth trails more attractive to mountain bikers as it will ensure that at least one trail will be open for riding regardless of the weather.

Collectively, the proposed recreational amenities will make it easier for a variety of user groups, both Duluth residents and visitors, to enjoy the unique terrain and views of Spirit Mountain within the urban setting of Duluth.

- e. Are future stages of this development including development on any other property planned or likely to happen? **Yes** ___ No. If yes, briefly describe future stages, relationship to present project, timeline and plans for environmental review.

The Spirit Mountain Recreation Area Master Plan identifies future development projects such as expanded campground facilities, tubing hill, upper chalet parking enhancements, and future multi-use recreation development northeast of the lower chalet. The dates and funding sources for these potential future projects are unknown at this time.

Therefore, projects that were not identified in Section 1.1.6 are not included as part of the proposed project. These future projects are not covered by the same funding source nor are they beyond the master planning stage nor scheduled for implementation at this time.

- f. Is this project a subsequent stage of an earlier project? **Yes** ___ No. If yes, briefly describe the past development, timeline and any past environmental review.

The proposed project is a continuation of the past developments outlined in Table 6-3. The existing trails within the Spirit Mountain Recreation Area boundary are shown on Figure 1.

Table 6-3 Environmental review and timeline for past developments

Past development	Timeline	Environmental Review
Spirit Mountain disc golf course (14 holes interspersed between alpine downhill runs within the proposed the Disc Golf Zone)	2014	NA
Spirit Mountain downhill mountain bike trails (approx. 6 miles)	2013	NA
Duluth Traverse mountain bike trail system (approx. 100 miles)	2013	Environmental Assessment Worksheet (EAW)
Cross City Trail (approx. 16 miles)	2009	Categorical Exclusion
Superior Hiking Trail (approx. 300 miles)	2005	Environmental Assessment Sheet (EAS)
Spirit Mountain Ski Hill (22 runs) & Nordic Cross Country Ski Trails (approx. 22 km)	1973	Environmental Impact Statement (EIS)

7. Cover Types

Estimate the acreage of the site with each of the following cover types before and after development:

The assessment of forest cover and other land cover types was estimated using GIS. The Esri ArcMap geometry calculator was used to calculate acreage through North American Datum 1983, Universal Trans Mercator 15N Projection, and the results are summarized in Table 7-1. Figure 7 shows the proposed improvements relative to the associated cover types in the study area.

Table 7-1 Cover types for proposed project components (acres)

Cover Type	Before	After
Wetlands	208.7	208.0
Deep water/streams	2.7	2.7
Wooded Forest	1130.6	1110.5
Brush/grassland	203.7	196.0
Cropland	0.0	0.0
Lawn/landscaping	190.7	190.7
Impervious surface	0.0	1.0
Stormwater Pond	0.0	0.0
Other (Trails)	42.3	69.9
Total Area	1778.7	1778.7

Due to the disc golf course's predominant location amongst the alpine downhill runs, aerial imagery was also used to assess and confirm the associated cover type changes for the proposed 18-hole disc golf course.

Approximately 31.6 total acres (approximately 1.8% of the total project area) will be temporarily disturbed for construction of the five proposed project components, including the proposed lower Nordic ski trail staging area and culvert installation. The trails will be constructed according to the IMBA sustainable trail building and/or the MNDNR trail planning, design, and development guidelines. The 20.2 acres (1.8% of the total forest area) of permanent forest cover type conversion represents primarily the clearing of understory vegetation to establish a trail corridor suitable to the corresponding recreational use. Specimen overstory trees will be maintained. The actual trail width for the majority of mountain biking trails will narrow from an initial width of 4 feet to 1.5 to 3 feet with an 8 foot high ceiling; this zone will be cleared of brush and small saplings for trail construction. The estimated 0.6 acres (0.3% of the total wetland area) of permanent wetland cover type conversion for the lower Nordic ski trails may require compensatory mitigation.

8. Permits and Approvals Required

List all known local, state and federal permits, approvals, certifications and financial assistance for the project. Include modifications of any existing permits, governmental review of plans and all direct and indirect forms of public financial assistance including bond guarantees, Tax Increment Financing and infrastructure. *All of these final decisions are prohibited until all appropriate environmental review has been completed. See Minnesota Rules, Chapter 4410.3100.*

Table 8-1 Permits and Approvals Required

Unit of Government	Type of Application	Status
City of Duluth	Shoreland Permit	To be submitted
City of Duluth	Wetland Conservation Act	To be submitted
City of Duluth	Erosion Control Permit	To be submitted
City of Duluth	Fill Permit	To be submitted
City of Duluth, Public Works Department	Stormwater General Construction Permit	To be submitted
MN State Historical Preservation Office (SHPO)	Archaeological and Cultural Resource Review (NHPA Section 106)	Received No Properties Determination 12-21-2015
Minnesota Pollution Control Agency (MPCA)	Stormwater General Construction Permit	To be submitted
Minnesota DNR	Public Waters Work Permit	Submit if needed
Minnesota Dept. Transportation (MNDOT)	Right-of-Way Permit	To be submitted
U.S. Army Corps of Engineers (USACE)	Section 404 Permit	To be submitted

9. Land Use

a. Describe:

- i. Existing land use of the site as well as areas adjacent to and near the site, including parks, trails, prime or unique farmlands.

The proposed project is being constructed on existing maintained alpine downhill runs as well as on undeveloped forest land where the primary use has been for recreational purposes within the boundary of the Spirit Mountain Recreation Area, on City of Duluth property, or on private property through an easement. The existing land use of Spirit Mountain includes alpine skiing and snowboarding, Nordic cross country skiing, mountain biking, hiking, snowmobiling, disc golf, camping, and other outdoor recreational uses. Residential communities and other private property, the Superior National Forest headquarters, and City of Duluth public parks are located adjacent to the Spirit Mountain Recreation Area off of Grand Avenue. Residents in the Norton Park neighborhood are located approximately 300 feet or more south/southeast of the proposed cross country mountain bike trail. At least one residential home along Bessemer Street located at least 200 feet south of the proposed lower Nordic ski trail, with the majority of homes located between 200 and 400 feet from the proposed trail.

- ii. Plans. Describe planned land use as identified in comprehensive plan (if available) and any other applicable plan for land use, water, or resources management by a local, regional, state, or federal agency.

The City of Duluth's Comprehensive Land Use Plan classifies the Spirit Mountain Recreation Area as "Recreation" over the ski hill and campground areas and "Preservation" over the remaining areas within the boundary of Spirit Mountain. The 2008 Spirit Mountain Master Plan discusses components of the proposed project throughout the plan, and specifically highlights many of the components in the Master Plan Implementation Actions. The 2010 MNDNR Knowlton Creek Stream Management Plan outlines objectives in working with Spirit Mountain to reduce sedimentation, decrease unnatural peak flows, and cool water before it flows into Knowlton creek. The stream management plan also calls for implementation of the comprehensive Knowlton Creek Watershed Project as laid out in the St. Louis River Habitat Plan.

- iii. Zoning, including special districts or overlays such as shoreland, floodplain, wild and scenic rivers, critical area, agricultural preserves, etc.

The City of Duluth's land use zoning authority was superseded in 1973 by state legislation that established the Spirit Mountain Recreation Area. The legislation provides a list of permitted uses including developing a wide range of recreational facilities to serve local residents and tourists. The legislation also establishes a process for creating and modifying a master plan for the Spirit Mountain Recreation Area, as well as approval of projects to implement the master plan.

There are several streams designated as trout streams within and adjacent to the study area. Knowlton Creek, a designated trout stream, runs through the Spirit Mountain Recreation Area and is located east of the existing alpine downhill runs. The proposed cross country mountain bike trail alignment will cross Knowlton Creek and therefore be located within the shoreland area of this stream. Other trail segments will cross or be located within shoreland areas of two other trout streams. A proposed mountain bike alignment will be located within a shoreland area of a tributary to Kingsbury Creek. A proposed upper ski trail segment will be located near Stewart Creek. Figure 8 shows all of the streams and their respective shoreland zones within and adjacent to the Spirit Mountain Recreation Area. Figure 9 depicts floodplain areas.

At the base of the ski hill, a 500 foot Buffer Zone was created in a 1984 City Council resolution (#84-0889), but no legal easement was created as a result of the Council's resolution. The buffer was reduced to 200' in 2008 as part of the approval process of the Spirit Mountain Recreation Area Master Plan.

- b. Discuss the project's compatibility with nearby land uses, zoning, and plans listed in Item 9a above, concentrating on implications for environmental effects.

As explained in the question above, the City's zoning ordinance has been superseded by the 1973 Spirit Mountain Recreation Area enabling legislation and replaced by the master planning process for the recreation area that is reviewed by the City Planning Commission and Parks and Recreation Board and approved by the City Council. The City will encourage the latest update of this master plan to minimize impacts to shoreland areas, wetlands, and floodplains when establishing the location of future facilities utilizing many of the standards in the zoning ordinance as a guide. Shoreland areas, wetlands and flood plains are shown in Figures 8, 10 and 11.

Compatibility with nearby land uses includes ambient noise in the EQB guidance definition of the environment. The project modeled ambient noise levels with the proposed project potential noise impacts in order to comply with MPCA daytime and night time noise standards.

The proposed recreational amenities are compatible with the Spirit Mountain Master Plan Implementation Actions, which specifically identify the following items:

- Improved Camping, Parking, and Nordic Areas
 - Establish short, lighted trail loop, possibly with snowmaking capacity, for Nordic trail system.
- Summer Facilities
 - Install new recreational summer facilities such as a zip line ride, mountain bike trails with lift access, disc golf, and mountain bike terrain park.
 - Create new hiking trails across the property and connecting with the Duluth Zoo and Munger / Western Waterfront Trails.

- Spirit Mountain will work cooperatively with the Superior Hiking Trail Association to minimize impacts to the Superior Hiking Trail that may result from expansion or new development.
- Other Actions
 - Work with Nordic ski users to develop major Nordic events.
 - Devise a management plan for the undeveloped, forested area of the SMRA property, which plan will focus on maintenance and enhancement of ecological values and functions, and, protection of cultural sites and values.

Additionally, the 2008 Spirit Mountain Master Plan discusses the importance of trails as follows:

“Trail systems at Spirit Mountain provide free or low-cost recreational opportunities for residents and visitors. They also offer users access to areas for enjoyment of the scenery and appreciation of the environmental features of the landscape. Trails can help integrate Spirit Mountain with regional systems such as the Superior Hiking Trail, Munger Trail, and the Western Waterfront Trail. Trails can also be used to connect Spirit Mountain with other area attractions such as the Duluth Zoo and Lake Superior & Mississippi Railroad. As part of its year-round programming, Spirit Mountain intends to position itself as a center for trail access, activity, and service.”

- c. Identify measures incorporated into the proposed project to mitigate any potential incompatibility as discussed in Item 9b above.

The water infrastructure and erosion control project, which was identified in the Spirit Mountain Master Plan, will allow the snowmaking operations to be removed from the City of Duluth water supply and was completed in the fall of 2015. This project included a reversible pipe that collects the runoff from snowmaking and rain events and returns that water directly to the St. Louis River to allow for erosion control and deflection of water away from Knowlton Creek which was requested by the MNDNR.

The proposed lower Nordic cross country ski trails are located near the residential community on Bessemer Street. To minimize potential impacts to these residents, efforts to reduce noise and light disturbances have been incorporated in the design, selection, and operation of snowmaking equipment, lighting, and snow grooming (see Appendix D for the noise analysis and mitigations options).

Information regarding the public process for the recreational improvements at Spirit Mountain has also been communicated to the residents potentially impacted by the project. A letter was also sent to the Bessemer Street residents on June 10, 2015 that outlined the proposed plans for the lower Nordic ski trails, the public process timeline, and an invitation for residents to continue a dialogue with City of Duluth staff regarding their concerns or questions. Additionally, a public meeting was also held with the Bessemer Street residents on August 11, 2015 to discuss the proposed plans for the lower Nordic ski trail. A second public meeting was held on March 21, 2016 to discuss revised plans and proposed mitigation with the Bessemer Street Residents.

- In order to meet MPCA day time and night time noise standards for all snow making activities in the area of the Bessemer Street residents, Spirit Mountain will incorporate the use of three silent pole cat snow makers and three kid pole cat snow makers to minimize noise levels of night time snow making. In addition, groomer noise was evaluated; recommendations were made modify motor noise with additional mufflers or modify engine speed in order to comply with MPCA standards.
- In order to reduce light disturbance to area residents, the project will install dark sky compliant, down facing lighting structures with house shielding.
- In order to provide visual screening to the residents whose views have been compromised, conifers trees will be planted.

10. Geology, Soils and Topography/Land Forms

- a. Geology – Describe the geology underlying the project area and identify and map any susceptible geologic features such as sinkholes, shallow limestone formations, unconfined/shallow aquifers, or karst conditions. Discuss any limitations of these features for the project and any effects the project could have on these features. Identify any project designs or mitigation measures to address effects to geologic features.

The Spirit Mountain Recreation area is located on the Duluth Complex, a large metamorphic and igneous rock formation. The underlying bedrock consists of Upper Precambrian (Middle Proterozoic) basalt, rhyolite, gabbro, diabase, anorthosite, granite, sandstone, and shale. Bedrock outcroppings are common and soils are commonly shallow. No susceptible geologic features have been identified within the project area. The depth of ground water and bedrock varies throughout the site due to the nature and depth of glacial till. Bedrock is exposed on parts of the proposed downhill trail alignments and in other areas it may be buried deep under the soil. Seeps and wet soils have been identified throughout the site and will be avoided where possible or when unavoidable will be crossed with bridges, boardwalks, and/or culverts.

- b. Soils and Topography – Describe the soils on the site, giving NRCS (SCS) classifications and descriptions, including limitations of soils. Describe topography, any special site conditions relating to erosion potential, soil stability or other soils limitations, such as steep slopes, highly permeable soils. Provide estimated volume and acreage of soil excavation and/or grading. Discuss impacts from project activities (distinguish between construction and operational activities) related to soils and topography. Identify measures during and after project construction to address soil limitations including stabilization, soil corrections or other measures. Erosion/sedimentation control related to stormwater runoff should be addressed in response to Item 11.b.ii.

Soils on the site are developed from rocky, red tills of the Superior Lobe. Textures range from sand to clay with an organic topsoil layer (see Figure 9 for specific soil classifications).

Steep slopes are present throughout the site, which presents desirable recreational and visual value while also creating conditions requiring special attention to minimize erosion concerns. The trails will be designed and constructed according to the IMBA sustainable trail building and/or the MNDNR trail planning, design, and development guidelines. Steep slope and highly erodible soils will be avoided, routed around, or built at such a shallow pitch that erosion would not be an appreciable concern. The purpose of the sustainable trail design and construction is to minimize any erosion issues and minimize the maintenance requirements of the trail. Trail segment closure and/or rerouting of a trail may be considered as a solution, should a chronic erosion problem arise. In the event that an erosion problem develops, corrective action will be taken to eliminate the problem. Maintenance will be performed to restore the condition of the trail. Erosion and sediment control best management practices (BMPs), such as minimizing the amount of exposed soil, grass berms, vegetation buffers, mulch or erosion blanket, silt fence, or biologs will be considered and used as appropriate during construction.

Acreage to be graded and excavated and volume of soil to be moved (and reused in other locations along the proposed trail alignments) are preliminary estimates based on assumptions of maximum trail width for each trail type (see Table 10-1) and the average grade of approximately 3% (hiking trails), 6% (Nordic ski trails), and 30% (mountain bike trails). Acreage: 31.6 acres; Volume: 42,300 cubic yards. This volume estimation assumes that no material will be excavated for the expansion of the disc golf course or the Rail-to-Trail conversion. Graded areas for the Nordic trails will be stabilized with a native seed mix appropriate for the area and mulch or erosion blanket.

Table 10-1 Maximum dimensions of project components

Trail	Location/Type	Maximum Width/Dimensions	Estimated Acreage	Estimated Volume
Nordic cross country ski trails	Lower	9 m (~30 feet)	7.2 acres	18,500 CY
	Upper, Connector	7 m (~23 feet)	4.3 acres	8,700 CY
	Staging area	36 m by 100 m (~118 feet by 328 feet)	0.9 acres	3,900 CY
	Snowmaking equipment Light poles	3 foot diameter, 50 to 500 foot spacing	~0 acres	Minimal
	Culverts	40 feet	0.5 acres	1,100 CY
Mountain bike trails	Natural surface, All weather, and Downhill	4 feet	4.8 acres	11,000 CY
Superior Hiking Trail	Lower spur	3 feet	0.2 acres	<50 CY
	Upper spur	1.5 feet	0.2 acres	<50 CY
Disc golf course	Fairways	40 feet	12.5 acres (total)	0 CY
	Tee box	4 feet by 9 feet, 2 foot buffer		
	Basket/green	2 feet, 3 inches		
	Alternate basket placement	30 foot diameter, 30 foot space (max of 4 per hole)		
Rail-to-Trail conversion	DWP railroad grade	10 feet	1.0 acre	0 CY
Combined Total			31.6 acres	Approx. 43,300 CY

11. Water Resources

- a. Describe surface water and groundwater features on or near the site in a.i. and a.ii. below.
 - i. Surface water - lakes, streams, wetlands, intermittent channels, and county/judicial ditches. Include any special designations such as public waters, trout stream/lake, wildlife lakes, migratory waterfowl feeding/resting lake, and outstanding resource value water. Include water quality impairments or special designations listed on the current MPCA 303d Impaired Waters List that are within 1 mile of the project. Include DNR Public Waters Inventory number(s), if any.

Within the project area, there are six waterways that will be crossed using new or existing bridges by the proposed mountain bike and Nordic ski trails; several drainage ways will also be crossed with new culverts for existing and proposed Nordic ski trails. The streams are listed in Table 11-1 and include (from west to east): 1) Lenroot Creek, 2) Gogebic Creek, 3) 85th Ave W Creek, 4) 84th Ave W Creek, 5) Knowlton Creek, and 6) 82nd Ave W Creek and several drainage ways that are crossed by existing Nordic ski trails.

Table 11-1 Number of existing and proposed waterway crossings

Waterbody	Existing Bridge	Proposed Bridge	Existing Culvert	Proposed Culvert
82 nd Ave W Creek	2	1	1	0
Knowlton Creek	4	1	2	0
84 th Ave W Creek	1	0	0	2
85 th Ave W Creek	0	1	1	5
Gogebic Creek	3	10	2	3
Lenroot Creek	0	1	2	1
Drainage ways	0	0	0	5

Knowlton Creek is a designated trout stream as well as public water. Other trout streams in the project area are Kingsbury Creek and its tributaries to the east and Stewart Creek to the west. No county/judicial ditches will be crossed by the project.

The St. Louis River and Kingsbury Creek are located within 1 mile of the proposed project and are currently listed on the Minnesota Pollution Control Agency’s (MPCA) Impaired Waters List (Table 11-2).

Table 11-2 MPCA 303d Impaired Waters List of surface waters within 1 mile

Waterbody	Reach Description	MPCA Affected designated use	Pollutant or Stressor
Kingsbury Creek	Mogie Lake to St. Louis River	Aquatic Life	Aquatic Macroinvertebrate Bioassessments
Kingsbury Creek	Mogie Lake to St. Louis River	Aquatic Life	Fishes Bioassessments
St. Louis River	Oliver Bridge to Pokegama River	Aquatic Consumption	Mercury in fish tissue
St. Louis River	Oliver Bridge to Pokegama River	Aquatic Consumption	PCB in fish tissue

- ii. Groundwater – aquifers, springs, seeps. Include: 1) depth to groundwater; 2) if project is within a MDH wellhead protection area; 3) identification of any onsite and/or nearby wells, including unique numbers and well logs if available. If there are no wells known on site or nearby, explain the methodology used to determine this.

The depth of ground water and bedrock varies throughout the site due to the nature and depth of glacial till. In some areas, ground water may be present near the surface and in other areas it may be located deeper underground. Seeps and wet soils have been identified throughout the site and will be avoided where possible or will be crossed with bridges, boardwalks, and/or culverts.

Three monitoring wells are located outside of the Spirit Mountain Recreation Area (Table 11-3). The Minnesota Department of Health’s County Well Index indicated that there are

also several domestic and abandoned wells located outside of the proposed project boundary.

Table 11-3 Off-site well locations

Well Type	Well Number	Elevation	Location
Monitoring	559200	722 ft	South of Gogebic Street
Monitoring	559199	727.36 ft	South of Gogebic Street
Monitoring	559198	729.04 ft	South of Gogebic Street
Domestic	450994	1128 ft	North of Skyline Parkway
Domestic	726895	1095 ft	North of Skyline Parkway
Domestic	786236	1091.2 ft	North of Skyline Parkway
Domestic	41494	1138 ft	North of Skyline Parkway
Domestic	745135	1180 ft	North of Skyline Parkway
Domestic	574861	1220 ft	North of Skyline Parkway

b. Describe effects from project activities on water resources and measures to minimize or mitigate the effects in Item b.i. through Item b.iv. below.

i. Wastewater - For each of the following, describe the sources, quantities and composition of all sanitary, municipal/domestic and industrial wastewater produced or treated at the site.

1. If the wastewater discharge is to a publicly owned treatment facility, identify any pretreatment measures and the ability of the facility to handle the added water and waste loadings, including any effects on, or required expansion of, municipal wastewater infrastructure.

No wastewaters are expected to be produced by the proposed project on a long term basis. Spirit Mountain is located within the Western Lake Superior Sanitary District (WLSSD) service area. Visitors to Spirit Mountain may utilize the dining and bar services provided within the lower or upper chalets, which would result in wastewater discharge to WLSSD. Portable toilets will be utilized during construction as appropriate and the resulting wastewater would be brought to WLSSD for processing by the provider. Any resulting wastewater is not expected to cause a significant increase to the daily WLSSD operations.

2. If the wastewater discharge is to a subsurface sewage treatment systems (SSTS), describe the system used, the design flow, and suitability of site conditions for such a system.

Not Applicable – the proposed project will not discharge wastewater to SSTS.

3. If the wastewater discharge is to surface water, identify the wastewater treatment methods and identify discharge points and proposed effluent limitations to

mitigate impacts. Discuss any effects to surface or groundwater from wastewater discharges.

Not Applicable – the proposed project will not discharge water to a surface water.

- ii. Stormwater - Describe the quantity and quality of stormwater runoff at the site prior to and post construction. Include the routes and receiving water bodies for runoff from the site (major downstream water bodies as well as the immediate receiving waters). Discuss any environmental effects from stormwater discharges. Describe stormwater pollution prevention plans including temporary and permanent runoff controls and potential BMP site locations to manage or treat stormwater runoff. Identify specific erosion control, sedimentation control or stabilization measures to address soil limitations during and after project construction.

With the exception of the all-weather mountain bike trails, the remaining trail surfaces will be a porous surface that will allow some water to penetrate. The trail surfaces will be packed down from usage and will not accept water as readily as the adjacent undisturbed surfaces. In most cases, the trail surface will have a slight outslope to shed water off the trail and grade reversals will be built into the trail periodically to shed any water that runs down the treadway off into a vegetated buffer. This will reduce the potential for generating sufficient volume and velocity to erode the trail. These gentle grade undulations (grade reversals), and the outward slope of the treadway, will minimize tread erosion by allowing water to drain off in a non-erosion manner called sheet flow. There should be no significant increase in surface water runoff from most of the trails because runoff will be filtered by adjacent undisturbed vegetation between the trail and the eight streams within the boundary of Spirit Mountain, which ultimately drain into the St. Louis River (Figure 1). This will result in on site infiltration and filtration before the water reaches any nearby waterbodies. The proposed improvements will require a Minnesota Pollution Control Agency construction stormwater permit and the preparation of a Stormwater Pollution Prevention Plan (SWPPP). The SWPPP will be followed during the construction of each project component. Erosion and sediment control best management practices (BMPs), such as minimizing the amount of exposed soil, grass berms, vegetation buffers, mulch or erosion blanket, silt fence, or biologs will be considered and used as appropriate during construction.

Due to the presence of special waters (Knowlton Creek, Stewart Creek, and Kingsbury Creek) and two impaired waters within 1 mile of the proposed trail alignments, all disturbed areas that drain to and are within 1 mile of the special and/or impaired waters will be stabilized immediately and within 7 days of final shaping of the project elements.

The additional snow required for the proposed lower Nordic ski trail will increase the surface water runoff into the downstream waterways, including 85th Ave W Creek, 84th Ave W Creek, and ultimately the St. Louis River. The City contracted with SEH, Inc., to study the additional expected runoff toward the Bessemer Street residents and design a solution to capture this runoff (see Appendix E).

The analysis by SEH, Inc. determined that the additional snow made will increase the snowpack by approximately 1.5 percent, with the amount of snow being made (and associated runoff) dependent on annual snowfall. Only during years with low snowfall will the lower Nordic ski trail require the full amount of additional snow making. A swale will be constructed to enhance the capture the runoff in the area of the residents. There may be some additional runoff that will flow to forested and other vegetated areas adjacent to the streams within the proposed ski trail system.

- iii. Water appropriation - Describe if the project proposes to appropriate surface or groundwater (including dewatering). Describe the source, quantity, duration, use and purpose of the water use and if a DNR water appropriation permit is required. Describe any well abandonment. If connecting to an existing municipal water supply, identify the wells to be used as a water source and any effects on, or required expansion of, municipal water infrastructure. Discuss environmental effects from water appropriation, including an assessment of the water resources available for appropriation. Identify any measures to avoid, minimize, or mitigate environmental effects from the water appropriation.

Snowmaking equipment will be installed in tandem with the lower Nordic cross country ski trails. Approximately 3.9 million gallons will be required per season to maintain an adequate snow base to ensure reliable trail coverage for recreational and racing use. The water for snowmaking for the proposed lower Nordic trails will be obtained as part of an updated water system that will be operational by November, 2015 and has not been included as part of this EAW.

Spirit Mountain currently has an approved water appropriation of up to 65 million gallons for snowmaking that is sourced from the St. Louis River. The water required for the lower Nordic ski trail snowmaking will be incorporated as part of the existing water appropriation permit (permit number 2015-0961).

- iv. Surface Waters

- a. Wetlands - Describe any anticipated physical effects or alterations to wetland features such as draining, filling, permanent inundation, dredging and vegetative removal. Discuss direct and indirect environmental effects from physical modification of wetlands, including the anticipated effects that any proposed wetland alterations may have to the host watershed. Identify measures to avoid (e.g., available alternatives that were considered), minimize, or mitigate environmental effects to wetlands. Discuss whether any required compensatory wetland mitigation for unavoidable wetland impacts will occur in the same minor or major watershed, and identify those probable locations.

The proposed mountain bike and hiking trail alignments will cross wetlands using elevated boardwalks approximately two feet wide to span the wetland on piers. No excavation or fill is proposed to construct these structures over wetlands. Cleared

brush will be lopped and scattered in upland locations. The proposed crossings will not involve the hydrologic alteration of wetlands, nor will it adversely affect the wetland functions. Compensatory mitigation is not required for the boardwalk structures, which do not require permits.

Wetland impacts are anticipated for the construction and maintenance of the proposed lower Nordic ski trails and for culvert installations in the upper Nordic ski trails. Wetlands are shown in Figure 11. The proposed alignment avoided wetland impacts where possible and identified the shortest crossing route where impacts were unavoidable. The final trail alignment will minimize wetland alternations to the maximum extent practicable. Compensatory mitigation may be required for any permanent wetland impacts in this area.

Although wetlands were identified when assessing land cover types, wetland impacts will be avoided during the disc golf course expansion by rerouting the course as necessary. No wetland impacts are anticipated for the Rail-to-Trail conversion.

- b. Other surface waters- Describe any anticipated physical effects or alterations to surface water features (lakes, streams, ponds, intermittent channels, county/judicial ditches) such as draining, filling, permanent inundation, dredging, diking, stream diversion, impoundment, aquatic plant removal and riparian alteration. Discuss direct and indirect environmental effects from physical modification of water features. Identify measures to avoid, minimize, or mitigate environmental effects to surface water features, including in-water Best Management Practices that are proposed to avoid or minimize turbidity/sedimentation while physically altering the water features. Discuss how the project will change the number or type of watercraft on any water body, including current and projected watercraft usage. The proposed mountain bike alignments will cross six streams (Figure 3) and the proposed upper hiking trail extension will cross one stream (Figure 4). Existing bridges will be used where available in ten locations; 14 new proposed stream crossings will use narrow timber bridges approximately 3 to 4 feet wide and will provide three feet of freeboard over any navigable stream (as shown in Appendix B). The bridges will be single span and tethered at one end to meet the DNR's requirements for temporary bridges. No excavation or fill below the ordinary high water mark is proposed or required to construct these structures over streams. The proposed crossings will not involve the hydrologic alteration of streams. No permit is required for this type of bridge.

The proposed lower Nordic cross country ski trails will cross four streams using culverts (Figure 2). Each culvert will be approximately 30 to 40 feet long and will be

properly designed to handle adequate flow rates and will follow MNDNR BMPs. Permits will be required for the culvert installations.

No new crossings of surface waters are anticipated for the proposed lower hiking trail extensions, the disc golf course expansion, or the Rail-to-Trail conversion.

12. Contamination/Hazardous Materials/Waste

- a. Pre-project site conditions - Describe existing contamination or potential environmental hazards on or in close proximity to the project site such as soil or ground water contamination, abandoned dumps, closed landfills, existing or abandoned storage tanks, and hazardous liquid or gas pipelines. Discuss any potential environmental effects from pre-project site conditions that would be caused or exacerbated by project construction and operation. Identify measures to avoid, minimize or mitigate adverse effects from existing contamination or potential environmental hazards. Include development of a Contingency Plan or Response Action Plan.

An inactive leak at the Spirit Mountain Maintenance Building (number 6604) is the only documented potentially contaminated site within the proposed project boundaries and is located approximately 200 feet or more from any existing or proposed mountain bike trails.

The only potential for contamination from the proposed project would be accidental spills of fuel or other fluids for motorized tools and machinery used for construction and maintenance. For trail construction, only small capacity fuel containers (less than 10 gallons) will be carried to construction and maintenance sites. Refueling will be performed at least 100 feet from streams or wetland areas to minimize the impact of any fuel spill during refueling. Equipment operators will be required to perform daily checks on all equipment that holds fluids to verify that they are in good mechanical condition, free of any fluid leaks and equipped with spark arrestors if applicable. Spill kits with appropriate capacity will also be required for equipment operators to have onsite during construction activities. All spills will be immediately cleaned up and any resulting waste will be properly disposed.

- b. Project related generation/storage of solid wastes - Describe solid wastes generated/stored during construction and/or operation of the project. Indicate method of disposal. Discuss potential environmental effects from solid waste handling, storage and disposal. Identify measures to avoid, minimize or mitigate adverse effects from the generation/storage of solid waste including source reduction and recycling.

All solid waste generated during construction and maintenance will be carried out and properly disposed by the construction crews.

- c. Project related use/storage of hazardous materials - Describe chemicals/hazardous materials used/stored during construction and/or operation of the project including method of storage. Indicate the number, location and size of any above or below ground tanks to store petroleum or other materials. Discuss potential environmental effects from accidental spill or release of hazardous materials. Identify measures to avoid, minimize or mitigate adverse effects from the

use/storage of chemicals/hazardous materials including source reduction and recycling. Include development of a spill prevention plan.

Not Applicable – the project will not require any new storage tanks.

- d. Project related generation/storage of hazardous wastes - Describe hazardous wastes generated/stored during construction and/or operation of the project. Indicate method of disposal. Discuss potential environmental effects from hazardous waste handling, storage, and disposal. Identify measures to avoid, minimize or mitigate adverse effects from the generation/storage of hazardous waste including source reduction and recycling.

Not Applicable – the proposed construction is not anticipated to generate any hazardous waste.

13. Fish, Wildlife, Plant Communities, and Sensitive Ecological Resources (Rare Features)

- a. Describe fish and wildlife resources as well as habitats and vegetation on or in near the site.

The MNDNR classifies this Ecoregion as the Laurentian Mixed Forest. The Spirit Mountain Recreation Area is found within the North Shore Highlands Subsection. Pre-settlement vegetation included aspen-birch forest, white pine-red pine forest, mixed hardwood-pine forest, and conifer bogs and swamps. White pine-red pine forest was most common on the clay lake plain and on thin soil over bedrock in the southern half of the subsection. Following logging activity of the early 20th century, the extensive white pine-red pine forests have been replaced by forests of quaking aspen-paper birch and northern hardwoods. Remnants of the pine forests can be seen today at Spirit Mountain (see Figure 7).

According to the MNDNR website, the Duluth Area Fisheries Office regularly stocks Kingsbury Creek with brook trout and Stewart Creek with rainbow trout. No other trout stocking information was provided for the other streams within the SMRA. Other species of fish found in the St. Louis River include walleye, northern pike, muskellunge, small mouth bass, largemouth bass, and sturgeon. Common mammals found in the area are black bear, whitetail deer, beaver, red fox, martin, chipmunks, and squirrels. Frequently observed reptiles and amphibians include turtles, frogs and snakes. Some of the most common observed bird species include: American redstart, red-eyed vireo, ovenbirds, chickadees and cedar waxwings.

- b. Describe rare features such as state-listed (endangered, threatened or special concern) species, native plant communities, Minnesota County Biological Survey Sites of Biodiversity Significance, and other sensitive ecological resources on or within close proximity to the site. Provide the license agreement number and/or correspondence number (ERDB#) from which the data were obtained and attach the Natural Heritage letter from the DNR. Indicate if any additional habitat or species survey work has been conducted within the site and describe the results.

Coordination with the MNDNR Natural Heritage Section under Barr Engineering's license agreement LA-585 (correspondence number #20160046) identified rare species within the project study area. Although the DNR states that the Sugar Maple-Basswood-(Bluebead Lily) Forest and Bedrock Shrubland are rare communities in Minnesota, they are not statutorily protected. The State's Endangered and Threatened Species Statue provides DNR the regulatory authority only to

prohibit the taking of species listed as endangered or threatened. Species of Special Concern, rare natural communities and SBS [Sites of Biodiversity Significance] areas aren't protected under the Statute. That being said, the proposed project already incorporates the DNR's suggestions in the ways listed below. Since one of the purposes of the project is to facilitate public enjoyment of nature, the project proponents have protection of natural communities as an important component of the trail design.

A field survey was conducted in July 2015 by Daniel Jones, Barr Engineering Company, to review the potential impacts to threatened and endangered species by the proposed project. The results of the field survey determined that no threatened or endangered species would be affected by any of the proposed project components.

- c. Discuss how the identified fish, wildlife, plant communities, rare features and ecosystems may be affected by the project. Include a discussion on introduction and spread of invasive species from the project construction and operation. Separately discuss effects to known threatened and endangered species.

All proposed construction activity will temporarily disturb the surrounding wildlife habitat and plant communities. The project may affect fish populations in the streams if erosion and sediment loss are not properly controlled and managed. The additional 3.9 million gallons of water for snowmaking for the lower Nordic ski trails represents a 6 percent increase from the existing 65 million gallons of water that have been appropriated for snowmaking for the alpine runs. This additional volume of water is not anticipated to impact the wet mesic habitat present in this low lying area of Spirit Mountain.

The proposed bridges will not affect fish populations because the bridges will span the streams and no work will be accomplished within the channel. Culverts are typically installed using a dam and pump bypass system to provide continued flow in the stream around the construction area while constructing the crossing under dry conditions, and thereby minimize sediment discharge downstream which could affect fish populations. Culvert installations will require permits that will require best management practices such as the dam and pump system to avoid impacts to fish and other stream populations. The proper use of best management practices will minimize erosion and sediment loss protecting these natural resources. Quickly seeding disturbed areas along trail corridors with natural seed mixes will help vegetation and habitat.

The proposed project was surveyed and proposed trail alignments and the disk golf course were located away from known threatened and endangered species populations in the area. Therefore threatened and endangered species will not be affected by the proposed improvements.

Although the ski hill at Spirit Mountain has been in existence for a little more than 40 years, most of the disturbance to the forest ecosystems has occurred with its development. Most of the trail system and ski slopes already exist, and area neighbors and visitors continue to observe wildlife such as whitetail deer and black bear in their natural habitat as reported at meetings with area residents. Scientific literature is available upon request that discusses the temporary dispersal of

wildlife to adjacent cover when human interactions occur. Wildlife species are not necessarily going to leave the recreation area because someone is hiking, biking, or skiing along an established trail system within the recreation area.

Evaluation of habitat alteration impacts can be carried out on a species-by-species basis, which is valuable for species of concern (threatened or endangered species), but such an analysis of every individual species and every single ecological process is an insurmountable task and of limited value (Lindenmayer and Fischer, 2006. *Habitat Fragmentation and Landscape Change: An ecological and conservation synthesis*). A more useful, and insightful, habitat impacts evaluation approach is to evaluate the potential changes in landscape patterns (i.e., vegetation structure, disturbance history) and any impacts upon species assemblages (i.e., bird communities, tree diversity). This landscape pattern approach to habitat evaluation asks two questions, 1) what are the primary causes of habitat loss and thus, how can activities that create these changes be avoided, and 2) are any of the proposed changes outside the "normal" range of ecosystem disturbances? In answering the first question, there are six key areas of landscape change that need to be evaluated with regard to habitat change or loss. Each of these six components of the first question are further explored below:

1. Does the proposed project reduce habitat size or create fragmentation?

When forested plant communities are converted to large expanses of open communities, there are corresponding changes in wildlife communities. Species that rely on well-developed forest canopies for nesting, foraging, or shelter are displaced from the portions of the landscape where this alteration occurs. There are no additional large-scale conversions or fragmentation of forest land proposed as part of the project.

The proposed improvements would close and restore 0.1 miles of one section of an Upper Nordic ski trail to natural vegetation, stop erosion and provide improved wildlife habitat. The 31.6 acres of proposed trails and disc golf course, which provides access to all visitors in the Spirit Mountain Recreation Area, occupies approximately 1.8% of the total area. When combined with the existing trails and ski runs, more than 85% (1,517 acres) of the recreation area will remain as wildlife habitat.

At the same time, there will be a net gain of 28.6 miles of multi-use trails in the recreation area. The 1.5 to 4 foot-wide hiking and biking trails will not remove the forest canopy, do not create new open areas, and will not present a significant adverse effect on 1,517 acres of wildlife habitat in the recreation area's 1,779 acres.

When habitat loss reaches and surpasses a certain threshold, negative impacts can occur. This is due to loss of plant community composition and structure which reduces habitat available to animal species and thus can reduce species abundance and reproduction success. Most research has shown that habitat loss thresholds are variable across species; salamanders need 20% to 30% forest cover, therefore impacts won't be seen until there is a 70% to 80% decrease in habitat area (Homan, et al 2004). Birds and mammals see declines when less than 10% to 30% of the

landscape is suitable habitat, which equals a 70% to 90% decrease in habitat area (Andren 1994). Wood frogs require 88% of adjacent areas to be in suitable habitat to prevent declines, which equals a 12% decrease in habitat (Homan, et al 2004). Fungal species have reduced reproduction when suitable habitat is less than 60%, which equals a 40% decrease in habitat (Otten, et al 2004). Moth abundance is reduced when suitable habitat is less than 40% to 50%, which equals a 40% decrease in habitat (Schmidt and Roland 2006). Amphibians generally decline when suitable habitat is less than 55% to 60%, which equals a 40% decrease in habitat (Gibbs 1998; Homan et al 2004). [References available upon request]

Habitat fragmentation can reduce the size of contiguous blocks of vegetation; this reduces the total area of contiguous habitat available to wildlife species and increases the isolation of the habitat. The alteration of plant community composition and structure can adversely affect those species that rely on the presence of certain plant species or vegetative cover. Fragmentation effects are greatest where large contiguous blocks are broken up into smaller patches that reduces interior forest habitat necessary for some species such as song birds. No such fragmentation will result from most of the trails on the project because the trails are approximately 2-4' wide and go around canopy trees. The proposed construction of the lower Nordic trails will affect approximately 7 acres. While this will change the vegetation structure to mostly grasses and flowering plants it is not a large expanse of open area leaving small remnants of forested fragments and therefore is not significant adverse impact to the recreation area.

As can be seen in Table 13-1, all of the habitat changes proposed as part of the next phase of the Spirit Mountain Master Plan Implementation are relatively small in size and will not present a significant adverse effect on 1,517 acres of wildlife habitat in Spirit Mountain's 1,779 acres.

Table 13-1 Habitat Changes by Cover Types

Habitat Changes by Cover Types	Before	After	% change
Wetlands	208.7	208.0	-0.3%
Deep water/streams	2.7	2.7	0.0%
Wooded Forest	1130.7	1110.5	-1.8%
Brush/grassland	203.7	196.0	-3.8%

2. Does the proposed project result in a change in vegetation structure?

The proposed hiking and biking trails will not create openings in the forest canopy. The exception to this will be a net change of approximately 7 acres of trees and shrubs for the lower Nordic ski trails which will be converted to grasses and forbs. The proposed ski trails will not create a significant alteration of the wildlife habitat (7 acres compared to 1,517 acres of wildlife habitat in Spirit Mountain's 1,779 acres. Species that rely on shrub layer or ground layer habitats may be less susceptible to, and often benefit under alterations because the changes in vegetation community structure and environmental factors, such as light intensity, lead to greater plant

diversity from hiking and biking trails (Burt and Rice 2009; Lindenmayer and Fischer 2011; Eldergard et al 2015). [References available upon request]

3. Does the proposed project lead to a loss of connectivity?

Habitat area is important, but equally important is access to adjoining suitable habitat. Fragmentation effects are greatest where large contiguous blocks are broken up into smaller patches that reduces interior forest habitat necessary for some species such as song birds. No such fragmentation will result from the proposed project since it does not create any barriers to plant and animal dispersion or movements. The 1.5 to 4 foot-wide trails will not remove the forest canopy, do not create new open areas, and will not present a significant adverse effect on 1,517 acres of wildlife habitat in Spirit Mountain's 1,779 acres. The proposed ski trails will create new narrow open areas are not a large expanse of open area leaving small remnants of forested fragments which will not result in a significant loss of connectivity. Where possible, the proposed disc golf course will use open areas along ski slopes. Additional small openings will be added but this will not cause a significant loss of connectivity.

4. Does the proposed project lead to a loss of habitat buffer area?

The proposed project does not remove or alter habitat buffers in or around Spirit Mountain. Trails are located within the different plant communities (woodland, wetland, etc.) and most segments are not along the transitional edges of the plant communities where impacts upon habitat buffers or ecotones would be greatest. See Figure 11.

5. Does the proposed project lead to a loss of heterogeneity?

The proposed trails will create some heterogeneity by creating an edge effect along the trails within the forested communities. Overall the proposed trails will not significantly reduce wildlife habitat.

6. Does the proposed project introduce invasive species?

Non-native invasive or pioneering plant species may encroach where disturbance provides a competitive advantage and an avenue of introduction. Additionally, machine graded trails will create bare ground which can provide an opportunity for introduction of exotic or invasive species. This can be minimized with sanitation of equipment and reestablishment of native vegetation as soon as possible after disturbance. The proposed improvements would include native seeding, use of weed free mulches and cleaning of construction equipment to minimize introduction of invasive species. The trail system, most of which is currently in place, provides access to Spirit Mountain and occupies approximately 4.0% of the total recreation area.

For all of the six "measures of habitat reduction" discussed above, the answer is that the proposed project does not significantly decrease habitat area in the Spirit Mountain Recreation Area.

- d. Identify measures that will be taken to avoid, minimize, or mitigate adverse effects to fish, wildlife, plant communities, and sensitive ecological resources.

The trail design will incorporate the DNR recommendations, as feasible, bearing in mind that another purpose of the project is providing better access to the natural elements of the Spirit Mountain Recreation Area. The project will employ measures to follow DNR suggestions where feasible to reduce construction and maintenance activities in sensitive areas, including:

- Operate as much as possible within already-disturbed areas;
- Avoid routing trails through wet swales or depressions, or sensitive rock outcrop areas;
- Bridge all stream and wetland crossings;
- Minimize vehicular disturbance in the area (allow only vehicles/equipment necessary for construction activities);
- Do not park equipment or stockpile supplies in sensitive areas;
- Do not place spoil within Minnesota Botanical Survey (MBS) sites or other sensitive areas;
- Inspect and clean all equipment prior to bringing it to the site to prevent the introduction and spread of invasive species;
- Use effective erosion prevention and sediment control measures;
- Trail maintenance plans should address erodible soils, especially in areas of steep topography;
- Revegetate disturbed soils with native species suitable to the local habitat as soon after construction as possible; and
- Use only weed-free mulches, topsoils, and native seed mixes.

Areas of known endangered and threatened species will be carefully considered even though no MNDNR listed species were found within the proposed project trail segments or disc golf course. Trail alignments will avoid seeps and highly erodible and unstable soils that could potentially affect fish, wildlife, and rare or native plant communities. When wetland crossings cannot be avoided hiking and biking trails will incorporate bridges over wetlands and streams. Some culvert repairs are planned for wetland crossings by ski trails.

Construction specifications for the trails will include BMPs and language for limiting the spread of invasive vegetation species by construction equipment and personnel to wildlife, plant communities, and sensitive ecological resources. The proposed project will include standard BMPs to control erosion and sediment loss to protect fish species. In order to further avoid impacts to sensitive natural features, a pre-construction meeting will be held with the construction contractor to emphasize the need to avoid sensitive resources.

14. Historic Properties

Describe any historic structures, archeological sites, and/or traditional cultural properties on or in close proximity to the site. Include: 1) historic designations, 2) known artifact areas, and 3) architectural features. Attach letter received from the State Historic Preservation Office (SHPO). Discuss any anticipated effects to historic properties during project construction and operation. Identify measures that will be taken to avoid, minimize, or mitigate adverse effects to historic properties.

A Phase 1A cultural resources survey was conducted in early July 2015 for the proposed project at Spirit Mountain by the Duluth Archaeology Center, L.L.C. The survey resulted in recording one new archaeological

site and one group of possible burial mounds. The recommendations of the survey requested that two trail segments be relocated to avoid impacts to these resources. These trail segments have been relocated and a “no properties will be affected by this project” determination was made on December 21, 2015 by the State Historic Preservation Office (SHPO). See Appendix A for a copy of the letter received from the SHPO.

15. Visual

Describe any scenic views or vistas on or near the project site. Describe any project related visual effects such as vapor plumes or glare from intense lights. Discuss the potential visual effects from the project. Identify any measures to avoid, minimize, or mitigate visual effects.

Scenic views and vistas are available throughout Spirit Mountain Recreation Area. Measures have been taken to minimize visual effects of the proposed lighting along the lower Nordic ski trails to the nearby residential community by designing down-cast lighting infrastructure that is dark-sky compliant on shorter pole heights that will be 4 to 6 feet in height. In addition, the City has proposed house side shields on the light poles to prevent light trespass onto Bessemer Neighborhood properties. The edge of the Nordic ski trails shall not be closer than 200' to any dwelling in the Bessemer Neighborhood. Conifer Trees shall be planted to provide visual screening to those residents whose views have been compromised. The remaining proposed project components are not anticipated to have any visual effects or impairments to the existing scenic views or vistas.

16. Air

- a. Stationary source emissions - Describe the type, sources, quantities and compositions of any emissions from stationary sources such as boilers or exhaust stacks. Include any hazardous air pollutants, criteria pollutants, and any greenhouse gases. Discuss effects to air quality including any sensitive receptors, human health or applicable regulatory criteria. Include a discussion of any methods used assess the project’s effect on air quality and the results of that assessment. Identify pollution control equipment and other measures that will be taken to avoid, minimize, or mitigate adverse effects from stationary source emissions.

Not Applicable – no stationary sources of air emissions are part of the proposed project.

- b. Vehicle emissions - Describe the effect of the project’s traffic generation on air emissions. Discuss the project’s vehicle-related emissions effect on air quality. Identify measures (e.g. traffic operational improvements, diesel idling minimization plan) that will be taken to minimize or mitigate vehicle-related emissions.

With the 2014 construction of the lower chalet at Spirit Mountain, located off of Grand Avenue, there are now two access points to the Mountain’s facilities: Skyline Parkway and Grand Avenue. The existing access roads are operating at far less than design capacity. Therefore, traffic congestion which could cause additional vehicle-related emissions and affect air quality is not currently a problem.

In addition, the proposed project is not expected to generate significant traffic congestion, which would otherwise artificially increase air emissions. A small increase in vehicle-related air emissions may be expected as a result of increased year-round visitation to Spirit Mountain or during special

events at the Nordic Center. Special events are infrequent. Therefore, the proposed project is not expected to cause any significant decrease in air quality.

- c. Dust and odors - Describe sources, characteristics, duration, quantities, and intensity of dust and odors generated during project construction and operation. (Fugitive dust may be discussed under item 16a). Discuss the effect of dust and odors in the vicinity of the project including nearby sensitive receptors and quality of life. Identify measures that will be taken to minimize or mitigate the effects of dust and odors.

In addition to hand tools, some of the trail construction will be performed using small diesel or gasoline powered mechanized equipment such as mini- or full-sized excavators, mini-skid steers, powered wheelbarrows, chainsaws, brush-cutters, and weed-whackers. These tools will emit some exhaust fumes when being operated. The proposed trail construction will cause minimal dust and odors during daylight hours.

Wind-blown dust will be controlled with watering. Due to the nature of the trail construction practices and maintenance, these impacts will be temporary and of limited intensity. Maintenance of many of the trails will be primarily performed with zero emission hand tools. Where motorized equipment is required for trail maintenance, potential impacts will be of limited duration.

Dust from the use of the downhill and natural surface mountain bike trails will be minimal and localized due to the construction of these trails on native mineral soils. Additionally, the vegetation directly adjacent to the mountain bike trail corridors will mitigate any effects of dust experienced during dry weather periods.

17. Noise

Describe sources, characteristics, duration, quantities, and intensity of noise generated during project construction and operation. Discuss the effect of noise in the vicinity of the project including 1) existing noise levels/sources in the area, 2) nearby sensitive receptors, 3) conformance to state noise standards, and 4) quality of life. Identify measures that will be taken to minimize or mitigate the effects of noise.

Trail construction will be performed using both hand tools as well as small diesel or gasoline powered mechanized equipment (as described in Section 1.1.16.c). These tools will emit some noise during daylight hours. The construction is not expected to generate significant noise levels or violate daytime or nighttime noise standards. Measures will be taken to limit construction of the lower Nordic ski trails and portions of the natural surface cross country mountain bike trail to daytime hours to minimize disturbances to nearby residential communities.

The decibel range of the existing snow machines (Super Polecats) at Spirit Mountain ranges from 46 to 85 dBA depending on the distance and orientation to the snow making machine; (see Appendix D for additional information). Currently the Super Polecat snow making machines are located along the alpine downhill runs and are located a minimum of 1,000 feet or more from any residential housing, which conforms to state daytime and nighttime noise standards. The proposed snow machines for the lower Nordic ski trail snowmaking will be a combination of Silent Polecats (1-2) and/or Kid Polecats (4-5). These

quieter snow machines will be placed no closer than 200 feet from several residential homes located off of Bessemer Street, which will result in a decibel range below 50 dBA which meets the day time and night time noise standards. Orientation of the snow machine will be parallel with the trail and will be pointing away from homes. Noise from grooming equipment will be controlled by reducing motor rpms or with improved mufflers. The City is currently evaluating alternatives to reduce noise levels in grooming equipment with a better noise muffling system; additionally, the City will evaluate the need for planting of conifer trees (5'-6' tall trees) if additional screening is requested and needed based upon an evaluation for selected residences. The noise study associated with the Bessemer Street neighborhood with recommendations is located in Appendix D of this EAW.

18. Transportation

- a. Describe traffic-related aspects of project construction and operation. Include: 1) existing and proposed additional parking spaces, 2) estimated total average daily traffic generated, 3) estimated maximum peak hour traffic generated and time of occurrence, 4) indicate source of trip generation rates used in the estimates, and 5) availability of transit and/or other alternative transportation modes.

The Spirit Mountain Authority estimates that it has approximately 1,495 parking spaces available for visitors to the recreation area (Table 18-1, Figure 1). There are no new parking areas planned during construction or as a result of the proposed project. The Grand Avenue Soccer Field is used as a parking overflow area during large events.

Table 18-1 Estimated Existing Parking Spaces at Spirit Mountain

Parking Areas	Estimated Parking Spaces
Adventure Park Lot	65
Campground Lot	10
Team Room Lot	30
A Lot	520
B Lot	250
C Lot (Overflow)	120
D Lot (Rounder)	100
Grand Ave Lot (dirt and paved)	200
Grand Ave Soccer Field	200
Total	1,495

The City of Duluth does not have information on daily trips or origin and destination numbers for the Spirit Mountain Recreation Area. However MNDOT 2013 traffic maps (the most recent count) shows an estimated total average daily traffic on Skyline Parkway at Boundary Avenue was 4,200 vehicles per day (VPD). More recent traffic counts on Skyline Parkway were not available at the time of this environmental review. Although no hourly counts were generated, the estimated maximum

peak hour traffic generated is usually 10 percent of the annual average daily traffic (AADT), or in this case approximately 420 vehicles per hour, which is usually found during the commuting hours of 7 to 8 am or 4 to 5 pm. The City of Duluth typically experiences an average increase traffic factor of 1.2 over 20 years. However, a review of Duluth Traffic Count Maps show that traffic along Skyline Parkway has at a higher ratio in during the 14 year period from 1999 (2,760 vpd) to 2013 (4,200 vpd). Based on this trend, the 2016 AADT is estimated at 4,830 vpd and the projected traffic in 2036 (20 years) is expected to be 6700 vpd. As a rule of thumb, MNDOT generally look at upgrading 2-lane roads to 4-lane roads (adding an additional traffic lane) when the AADT is in the range of 10,000 to 15,000 vpd. Therefore, Skyline Parkway is expected handle the future traffic capacity for the foreseeable future.

Traffic on Grand Avenue (MNDOT Highway 23), which runs past the lower chalet, was measured at 11,500 vpd in 2013, and estimated at 11,845 for 2016. Likewise peak hour traffic would be expected to be about 1,180 vehicles per hour. Traffic along Grand Avenue has increased at a slower pace, closer to the typical traffic increases of 1.2 over 20 years. Based on this MNDOT traffic projection factor, the projected traffic in 2036 (20 years) is expected to be 14,210 vpd.

The Duluth Transit Authority connects visitors daily by bus to the lower chalet. No city bus goes to the main upper chalet. Visitors on Grand Avenue would need to purchase a lift ticket or find their own way to the top of the mountain. Bicyclists and hikers could connect with Spirit Mountain via existing streets and the intercity trails such as the Duluth Traverse Trail, the Cross City Trail, the Munger Trail and Western Waterfront Trail.

- b. Discuss the effect on traffic congestion on affected roads and describe any traffic improvements necessary. The analysis must discuss the project's impact on the regional transportation system. *If the peak hour traffic generated exceeds 250 vehicles or the total daily trips exceeds 2,500, a traffic impact study must be prepared as part of the EAW.* Use the format and procedures described in the Minnesota Department of Transportation's Access Management Manual, Chapter 5 (*available at: <http://www.dot.state.mn.us/accessmanagement/resources.html>*) or a similar local guidance.

The City does not have any data on projected users of the proposed trails at this time. Based on a review of the present traffic data and trends, the proposed project is not expected to generate an additional 250 vehicles per hour, or 2,500 trips per day on affected roads. During construction, there will likely be a temporary increase of 20 to 25 vehicle trips per day will be required during the workday (generally between 6 am and 6 pm). Contractors will work during weekdays using existing road ways and trails for staging equipment. The number of trips generated is not expected to adversely affect local traffic.

MNDOT is currently rehabilitating Grand Avenue (Highway 23) from Interstate 35 to Becks Road, St. Louis County Highway 3. No other highway improvements to Grand Avenue or Skyline Parkway are proposed at this time. MNDOT's improvement to Grand Avenue is not part of the proposed project. Potential congestion may occur during the ongoing road reconstruction activities on Highway 23, but not with the proposed construction related to this project.

The number of recreational users over time is expected to increase as a result of the proposed recreational improvements. Some congestion usually begins to appear when the AADT approaches 10,000 vpd. The AADT for Skyline Parkway and Grand Avenue is well below 10,000 vpd. Currently, Skyline Parkway and Grand Avenue both have adequate traffic capacity and are expected to accommodate the amount of traffic in the foreseeable future.

- c. Identify measures that will be taken to minimize or mitigate project related transportation effects. Special event traffic at Spirit Mountain is usually managed by providing with over flow parking lots and shuttle service to reduce congestion. MNDOT's Grand Avenue project will include an underpass for the hiking trail extension to the Western Waterfront Trail to reduce potential pedestrian-vehicle conflicts. The Duluth Transit Authority provides city bus service along Grand Avenue to the lower chalet. All city buses are set up to carry bicycles to provide multi-modal connections. This could help reduce seasonal parking needs.

During a public meeting, the area residents who live along Bessemer Street near the bottom of Spirit Mountain voiced their concern about visitors who use their limited neighborhood on street parking and then trespass through their yards to get to trails or other natural areas of Spirit Mountain. To address residents' concerns about Spirit Mountain visitors taking up local on street parking the City proposed the following action at the March 2016 public meeting:

- Parking for large scale events at Spirit Mountain will follow Spirit Mountain's Event Parking overflow plan
- There will be a fence installed at the intersection of the Riverside Drive ROW and Bessemer Street. Also a sign will be installed on that gates that states "No Trespassing"
- The City will install signs along Bessemer Street that say "On Street Parking for Residents Only"
- The City will:
 - i. Vacate unused ROW for alleyways and roads between Bessemer Street and the proposed trail
 - ii. Retain ROW along Riverside Drive for a future Trail Easement and not improve it or sign it for trail use

19. Cumulative Potential Effects

(Preparers can leave this item blank if cumulative potential effects are addressed under the applicable EAW Items)

- a. Describe the geographic scales and timeframes of the project related environmental effects that could combine with other environmental effects resulting in cumulative potential effects. The proposed project components will be in close proximity to other existing recreational trails such as the Superior Hiking Trail, Nordic ski trails, and alpine downhill runs within the Spirit Mountain Recreation Area. Given the relatively narrow corridors and footprint, all of these trails are not expected to present significant cumulative adverse effects to the environment. The Duluth

Traverse Trail System will connect to Spirit Mountain. The impacts of this trail system were analyzed in a previous EAW review. The Cross City Trail is currently under review by the City. One proposed alignment connects to Spirit Mountain and the Western Waterfront Trail. It is not clear at this time if the Cross City Trail will continue to connect with Spirit Mountain.

- b. Describe any reasonably foreseeable future projects (for which a basis of expectation has been laid) that may interact with environmental effects of the proposed project within the geographic scales and timeframes identified above.

At this time, there are no known future projects that may interact with the environmental effects of the proposed project within the Spirit Mountain Recreational Area. The Spirit Mountain Master Plan identifies additional projects that may be implemented in the future; however, there is currently no known timeframe or design work for implementing any additional projects that have not been outlined in this environmental review.

- c. Discuss the nature of the cumulative potential effects and summarize any other available information relevant to determining whether there is potential for significant environmental effects due to these cumulative effects.

The project will disturb approximately 31.6 acres (within the 1,779 acre project area) for the proposed trail segments and disc golf course. The proposed closure of one unsustainable trail segment will result in restoring this segment to its natural surrounding habitat. The proposed new trail segments will have a very small cumulative effect with the overall number of trails increasing. The new trail segments will temporarily remove brush and saplings in order to construct the project; however, the vegetation will grow back following the completion of the trail construction. This will provide an edge effect of nesting and hiding cover for many species of birds and mammals. The overall disturbance is not expected to cause significant adverse environmental effects since the area of impact is 1.8% of the project area. Additionally, BMPs will be used during the construction and operation of the project to minimize impacts to the surrounding environment.

20. Other Potential Environmental Effects

If the project may cause any additional environmental effects not addressed by items 1 to 19, describe the effects here, discuss the how the environment will be affected, and identify measures that will be taken to minimize and mitigate these effects.

No other additional environmental impacts were identified.

RGU CERTIFICATION. *(The Environmental Quality Board will only accept **SIGNED** Environmental Assessment Worksheets for public notice in the EQB Monitor.)*

I hereby certify that:

- The information contained in this document is accurate and complete to the best of my knowledge.

-
- The EAW describes the complete project; there are no other projects, stages or components other than those described in this document, which are related to the project as connected actions or phased actions, as defined at Minnesota Rules, parts 4410.0200, subparts 9c and 60, respectively.
 - Copies of this EAW are being sent to the entire EQB distribution list.

Signature _____ Date _____

Title _____

Figures

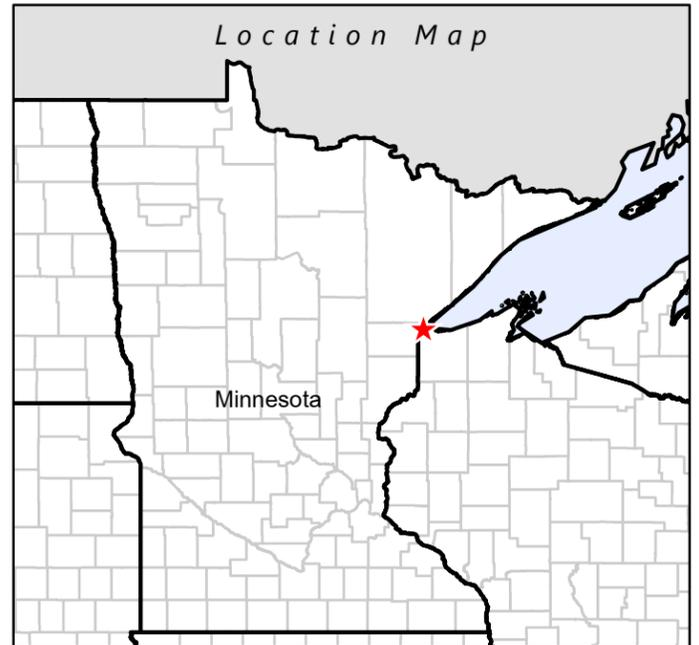
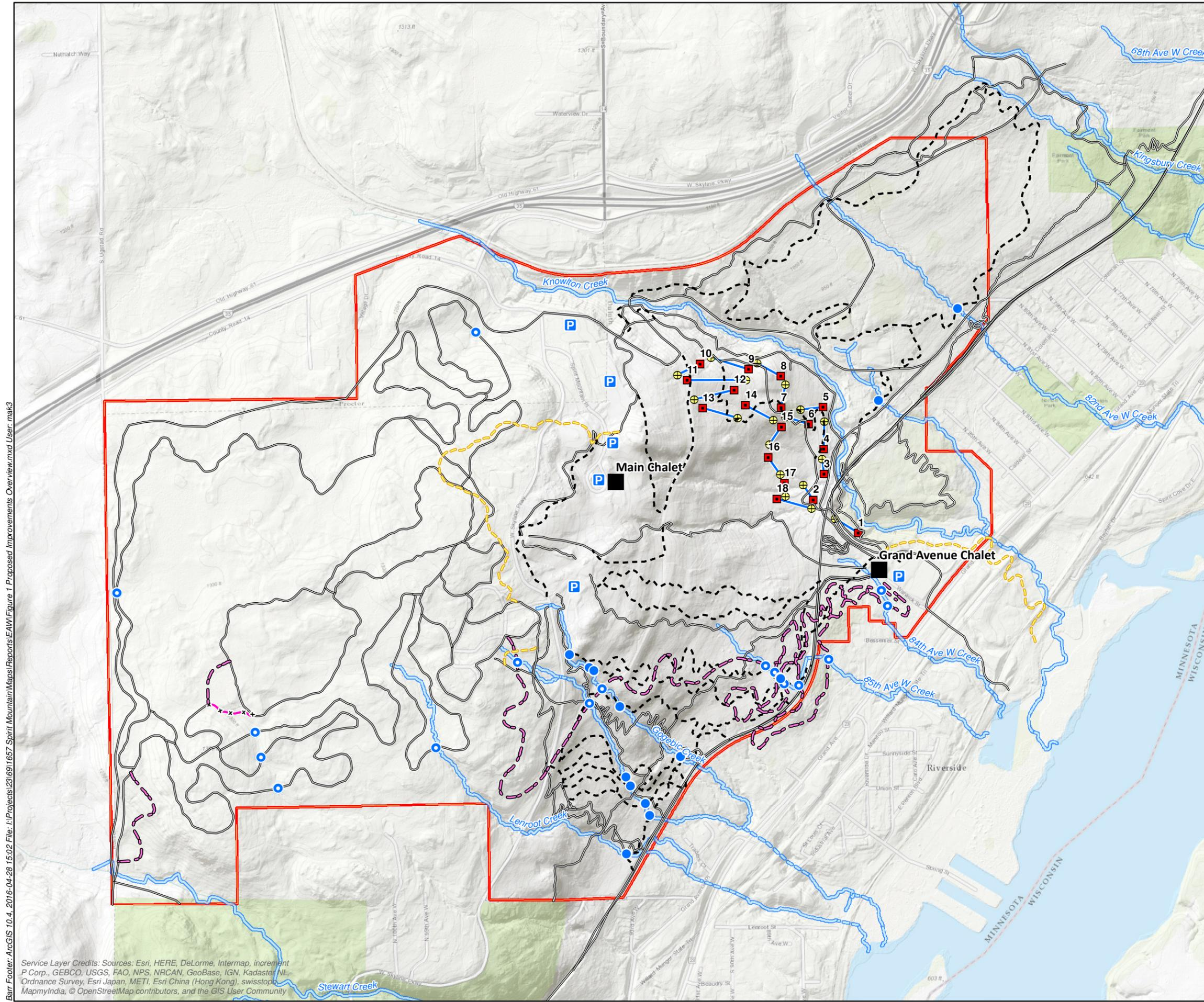

- Chalet
- Parking Area
- Spirit Mountain Boundary
- Existing Trails
- Proposed Bridge
- Proposed Culvert
- Disc Golf Course
- Basket
- Tee Pad
- Course Path
- Proposed Trails
- Mountain Bike
- Hiking
- Nordic Ski
- Trail to be Removed

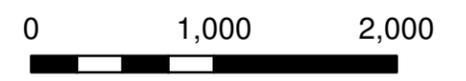

Feet
1 Inch = 1,000 Feet

Figure 1

SITE LOCATION
 Proposed Improvements Overview
 Spirit Mountain Recreation Area EAW
 City of Duluth
 St. Louis County, Minnesota



Barr Footer: ArcGIS 10.4, 2016-04-28 15:02 File: I:\Projects\231691657 Spirit Mountain\Maps\Reports\EAW\Figure 1 Proposed Improvements Overview.mxd User: mak3

Service Layer Credits: Sources: Esri, HERE, DeLorme, Intermap, increment P Corp., GEBCO, USGS, FAO, NPS, NRCAN, GeoBase, IGN, Kadaster NL, Ordnance Survey, Esri Japan, METI, Esri China (Hong Kong), swisstopo, MapmyIndia, © OpenStreetMap contributors, and the GIS User Community

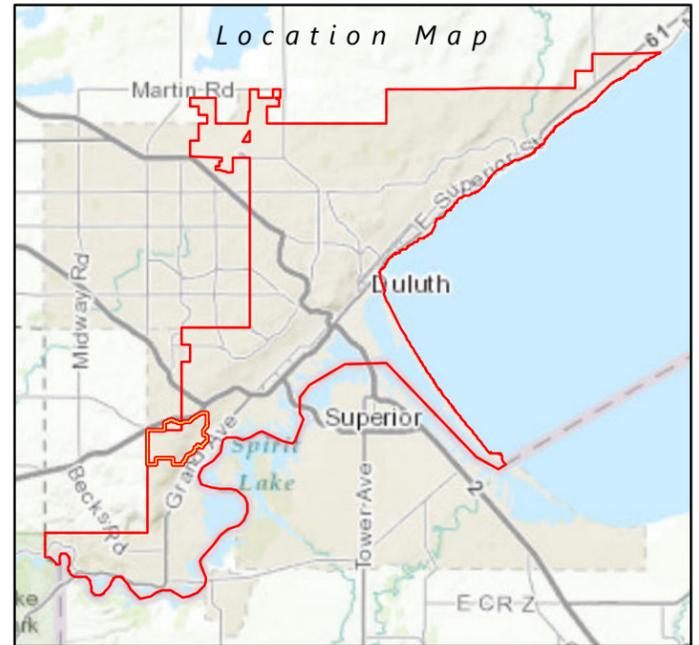
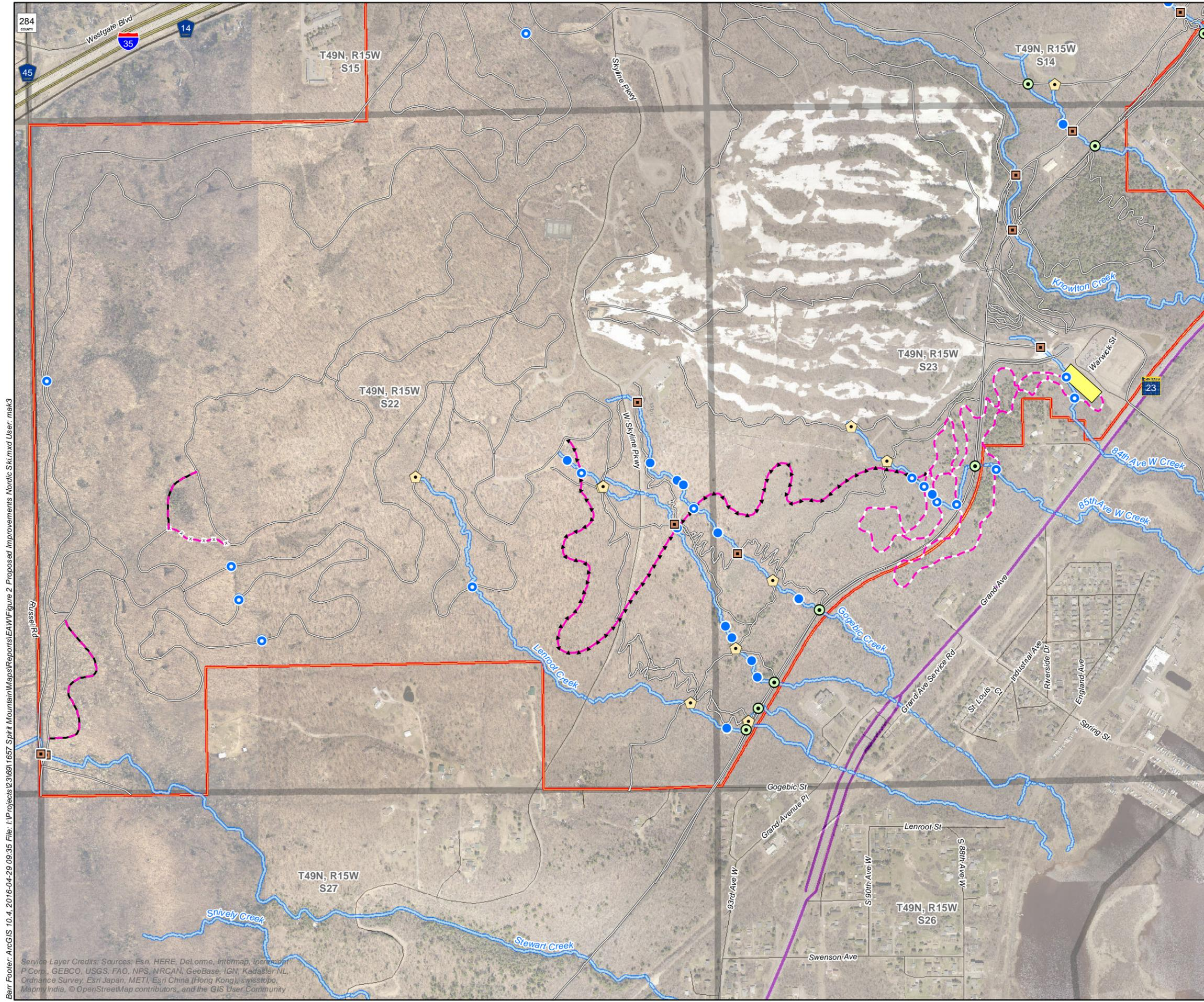

- Spirit Mountain Boundary
- Existing Bridge
- Existing Crossing
- Existing Culvert
- Existing Trails
- Rivers and Streams
- Surface Waters
- Underground (Culvert)
- Proposed Bridge
- Proposed Culvert
- Staging Area
- Proposed Trails
- Nordic Ski , Connector
- Nordic Ski , Lower
- Nordic Ski , Upper
- Trail to be Removed



Feet

1 Inch = 750 Feet

St. Louis County Imagery Circa May, 2013

Figure 2

NORDIC SKI TRAILS
 Proposed Improvements
 Spirit Mountain Recreation Area EAW
 City of Duluth
 St. Louis County, Minnesota



Barr Footer: ArcGIS 10.4.2016-04-29 09:35:55 File: I:\Projects\231691\657 Spirit Mountain Maps\Reports\EA\W\Figure 2 Proposed Improvements Nordic Ski.mxd User: mek3
 Service Layer Credits: Sources: Esri, HERE, DeLorme, Intermap, increment P Corp., GEBCO, USGS, FAO, NPS, NRCAN, GeoBase, IGN, Kadaster NL, Ordnance Survey, Esri Japan, METI, Esri China (Hong Kong), Swisstopo, MapmyIndia, © OpenStreetMap contributors, and the GIS User Community

Barr Footer: ArcGIS 10.4.2016-05-02 13:48 File: I:\Projects\2316911657 Spirit Mountain Maps\Reports\EAW\Figure 3 Proposed Improvements Mountain Bike.mxd User: mak3

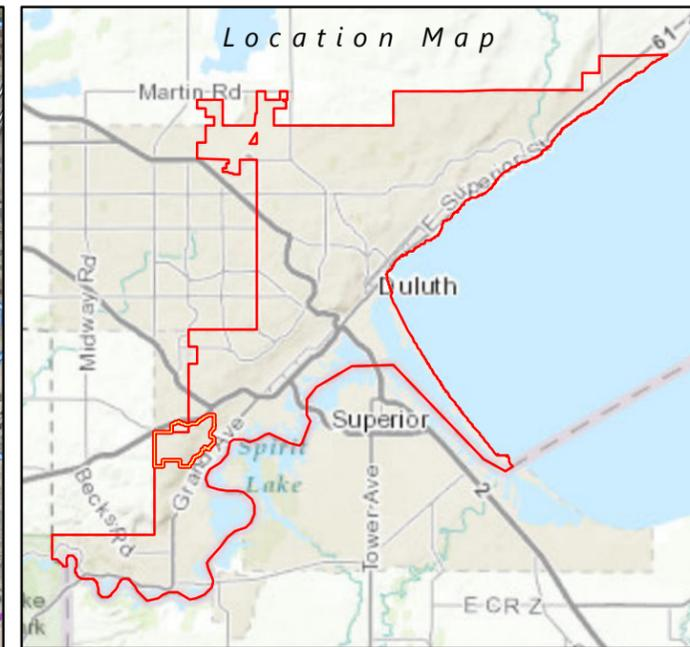

- Spirit Mountain Boundary
- Proposed Bridge
- Existing Bridge
- Proposed Culvert
- ◊ Existing Crossing
- Proposed Trails
- Existing Culvert
- Mountain Bike, All-Weather
- Existing Trails
- Mountain Bike, Downhill
- Rivers and Streams
- Surface Waters
- Underground (Culvert)
- Mountain Bike, Natural Surface

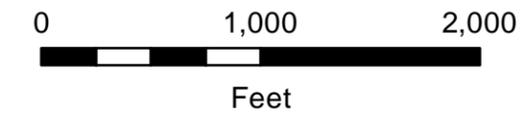

St. Louis County Imagery Circa May, 2013

Figure 3

MOUNTAIN BIKE TRAILS
 Proposed Improvements
 Spirit Mountain Recreation Area EAW
 City of Duluth
 St. Louis County, Minnesota



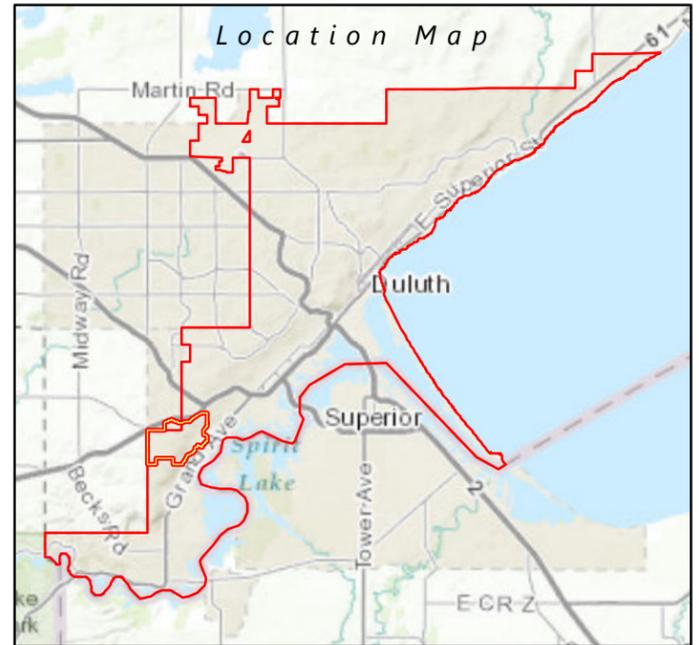

- Spirit Mountain Boundary
- Proposed Bridge
- Existing Bridge
- Proposed Culvert
- Existing Crossing
- Proposed Trails
- Existing Culvert
- Hiking
- Existing Trails
- Rivers and Streams
- Surface Waters
- Underground (Culvert)

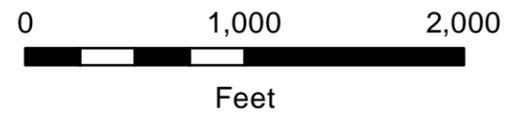

St. Louis County Imagery Circa May, 2013

Figure 4

HIKING TRAILS
 Proposed Improvements
 Spirit Mountain Recreation Area EAW
 City of Duluth
 St. Louis County, Minnesota



Barr Footer: ArcGIS 10.4, 2016-04-29 09:12 File: I:\Projects\2316911657 Spirit Mountain Maps\Reports\EAW\Figure 4 Proposed Improvements Hiking.mxd User: mak3
 Service Layer Credits: Sources: Esri, HERE, DeLorme, Intermap, increment P Corp., GEBCO, USGS, FAO, NPS, NRCAN, GeoBase, IGN, Kadaster NL, Ordnance Survey, Esri Japan, MEP, Esri China (Hong Kong), swiss topo, Mapbox, © OpenStreetMap contributors, and the GIS User Community

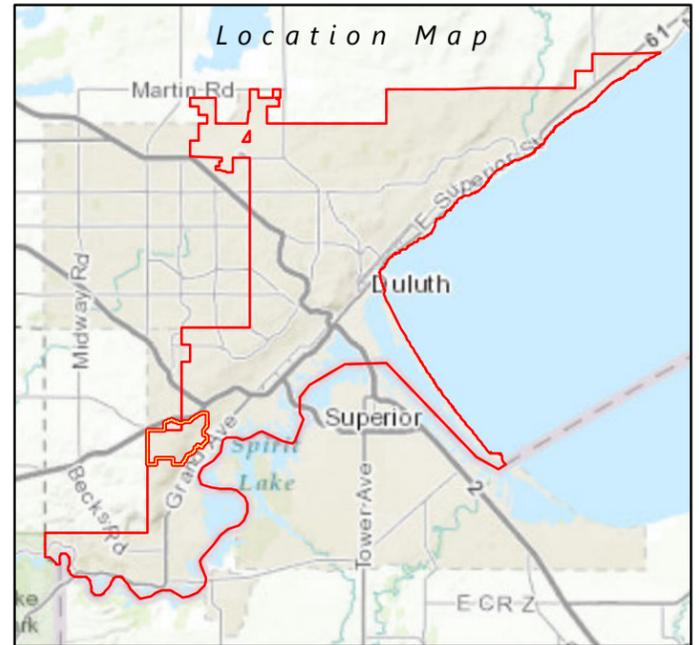

- Spirit Mountain Boundary
- Proposed Bridge
- Proposed Culvert
- Existing Trails
- Rivers and Streams
- Surface Waters
- Underground (Culvert)
- Proposed Trails
- Rail-to-Trail Multiuse

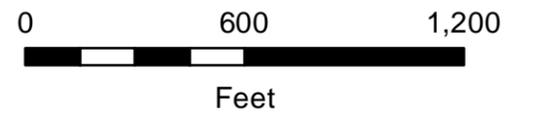

St. Louis County Imagery Circa May, 2013

Figure 5

RAIL-TO-TRAIL
 Proposed Improvements
 Spirit Mountain Recreation Area EAW
 City of Duluth
 St. Louis County, Minnesota



Barr Footer: ArcGIS 10.4, 2016-04-29 09:54 File: I:\Projects\231691\657 Spirit Mountain Maps\Reports\EA\W\Figure 5 Proposed Improvements Rail to Trail.mxd User: mak3

Service Layer Credits: Sources: Esri, HERE, DeLorme, Intermap, iPC, NITEL, GEBCO, USGS, FAO, NPS, NRCAN, GeoBase, Swisstopo, Ordnance Survey, Esri Japan, METI, Esri China (Hong Kong), Swisstopo, MapmyIndia, © OpenStreetMap contributors, and the GIS User Community

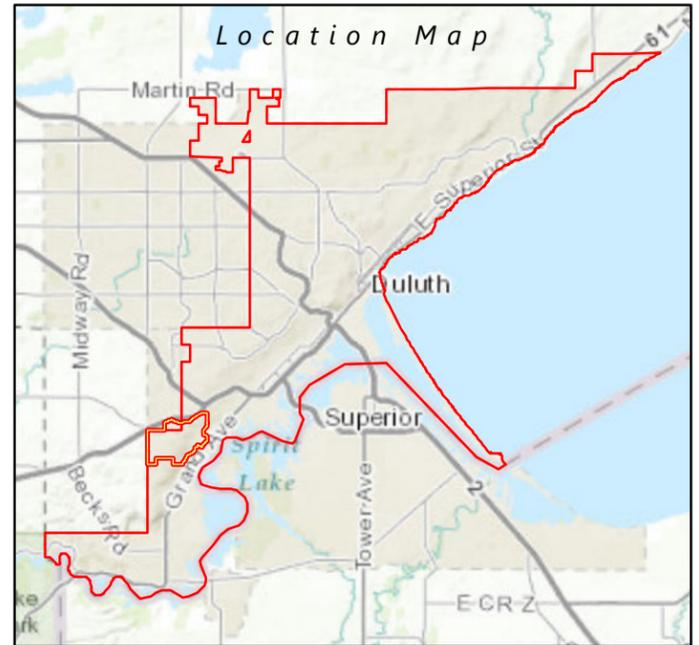
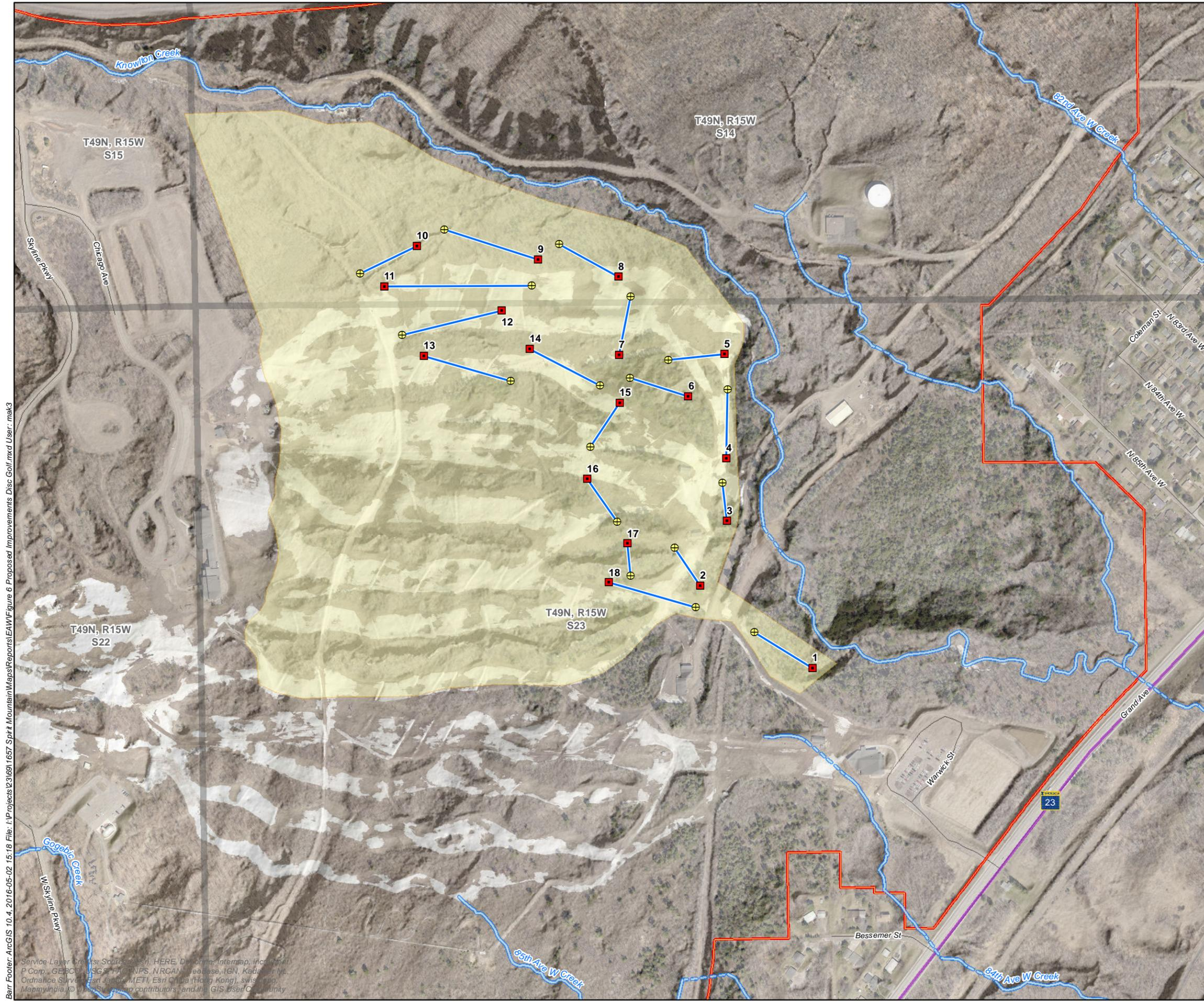

- Spirit Mountain Boundary
- Disc Golf Zone
- Disc Golf Course
- Basket
- Tee Pad
- Course Path
- Rivers and Streams
- Surface Waters
- Underground (Culvert)

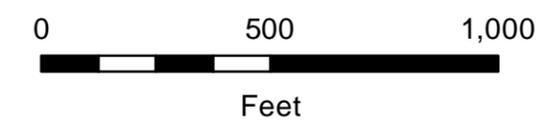

St. Louis County Imagery Circa May, 2013

Figure 6

DISC GOLF
 Proposed Improvements
 Spirit Mountain Recreation Area EAW
 City of Duluth
 St. Louis County, Minnesota



Barr Footer: ArcGIS 10.4.2016-05-02 15:18 File: I:\Projects\231691\657 Spirit Mountain Maps\Reports\EAW\Figure 6 Proposed Improvements Disc Golf.mxd User: mak3
 Service Layer Credits: Source: Esri, HERE, DeLorme, Intermap, Incorp., Swisstopo, P Corp., GEBCO, USGS, FAO, NPS, NRCAN, GEBCO, Swisstopo, IGN, Canada, NGA, Ordnance Survey, Esri Japan, METI, Esri China (Hong Kong), Swisstopo, MapmyIndia, © DeLorme, contributors, and the GIS user community

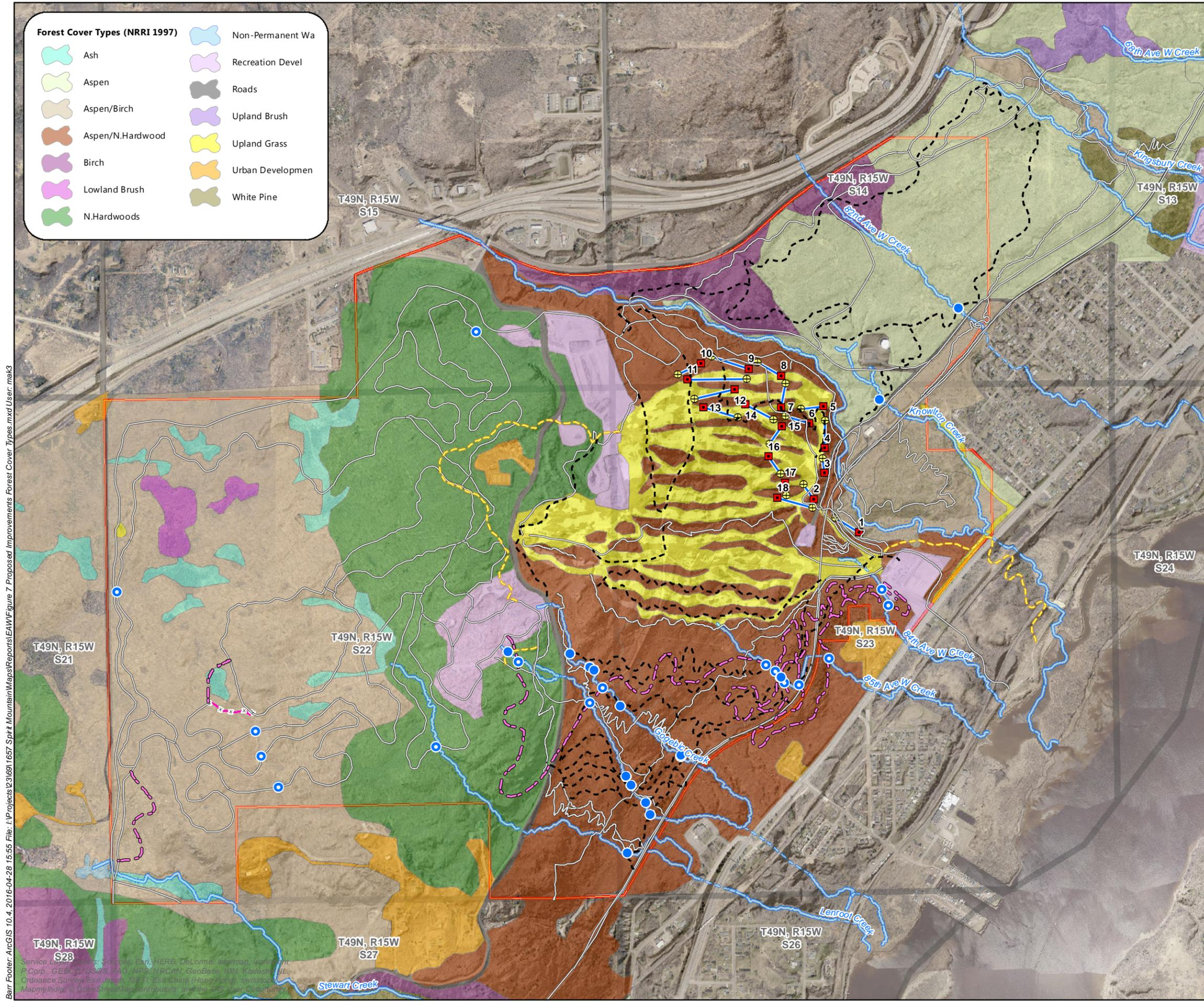

Forest Cover Types (NRRI 1997)

	Ash		Non-Permanent Wa
	Aspen		Recreation Devel
	Aspen/Birch		Roads
	Aspen/N.Hardwood		Upland Brush
	Birch		Upland Grass
	Lowland Brush		Urban Developmen
	N.Hardwoods		White Pine

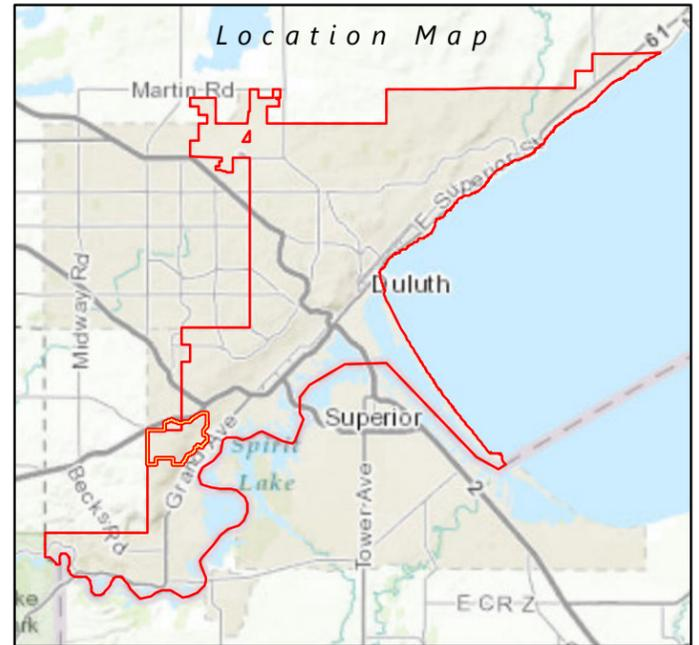

	Spirit Mountain Boundary		Disc Golf Course
	Proposed Bridge		Basket
	Proposed Culvert		Tee Pad
	Existing Trails		Course Path
	Rivers and Streams		Proposed Trails
	Surface Waters		Mountain Bike
	Underground (Culvert)		Hiking
			Nordic Ski
			Trail to be Removed

0 1,000 2,000
 Feet
 1 Inch = 1,000 Feet
 St. Louis County Imagery Circa May, 2013

Figure 7

FOREST COVER TYPES
 Proposed Improvements Overview
 Spirit Mountain Recreation Area EAW
 City of Duluth
 St. Louis County, Minnesota



Barr Footer: ArcGIS 10.4.2016-04-28 15:55 File: I:\Projects\231691657 Spirit Mountain\Maps\Reports\EA\W\Figure 7 Proposed Improvements Forest Cover Types.mxd User: msrk3

Service Layer Credits: Source: Esri, HERE, DeLorme, Intermap, iMap, Swire, P Corp., GEBCO, USGS, FAO, DigitalGlobe, GeoEye, IGN, AerGRID, CNR, Ordnance Survey, Esri, DeLorme, Swire, Swire, Swire, Swire, Swire, Swire, MapmyIndia, © OpenStreetMap contributors, and the GIS User Community

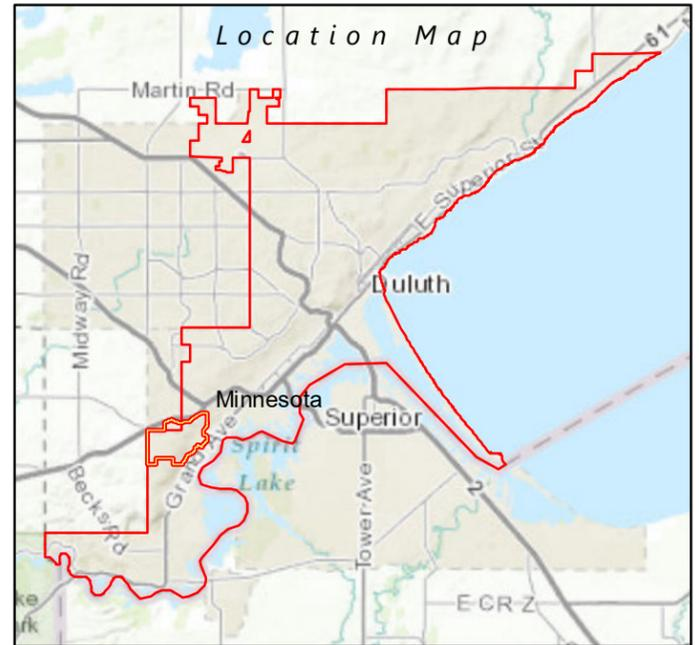

- Spirit Mountain Boundary
- Proposed Bridge
- Proposed Culvert
- Existing Trails
- Rivers and Streams
- Surface Waters
- Underground (Culvert)
- Shoreland (NRO)
- Disc Golf Course
- Basket
- Tee Pad
- Course Path
- Proposed Trails
- Mountain Bike
- Hiking
- Nordic Ski
- Trail to be Removed

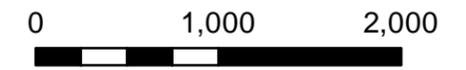

Feet
1 Inch = 1,000 Feet
St. Louis County Imagery Circa May, 2013

Figure 8

SHORELAND AREAS
Proposed Improvements Overview
Spirit Mountain Recreation Area EAW
City of Duluth
St. Louis County, Minnesota



Barr Footer: ArcGIS 10.4.2016-05-02 15:16 File: I:\Projects\231691\657 Spirit Mountain\MapReports\EA\W\Figure 8 Proposed Improvements Shoreland Areas.mxd User: mak3
 Service Layer Credits: Sources: Esri, HERE, DeLorme, Intermap, increment P Corp., GEBCO, USGS, FAO, NPS, NRCAN, GeoBase, IGN, Kadaster NL, Ordnance Survey, Esri Japan, METI, Esri China (Hong Kong), Swisstopo, MapmyIndia, © OpenStreetMap contributors, and the GIS User Community

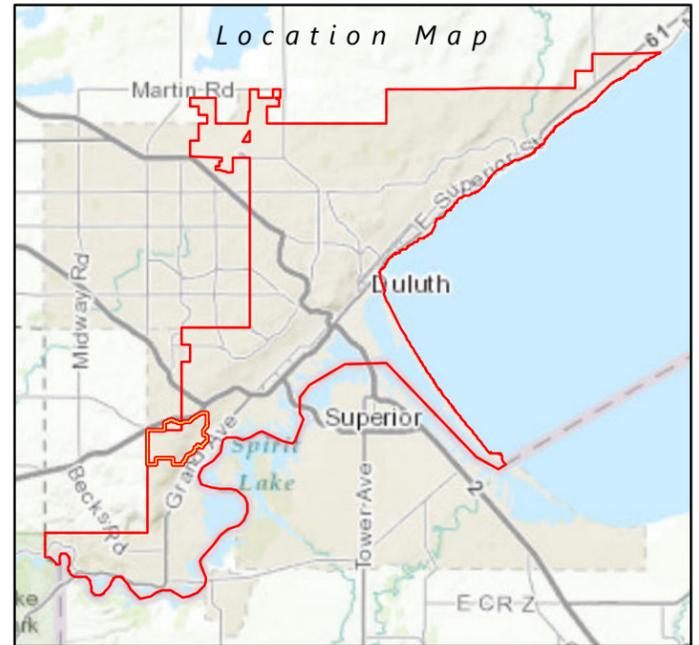

- Spirit Mountain Boundary
- Proposed Bridge
- Proposed Culvert
- Existing Trails
- Rivers and Streams
- Underground (Culvert)
- Floodplain (100yr)
- Disc Golf Course Basket
- Tee Pad
- Course Path
- Proposed Trails Mountain Bike
- Hiking
- Nordic Ski
- Trail to be Removed

Floodplain data originally obtained from City of Duluth-Duluth Traverse Project, reflects FEMA 1984 Floodplains.

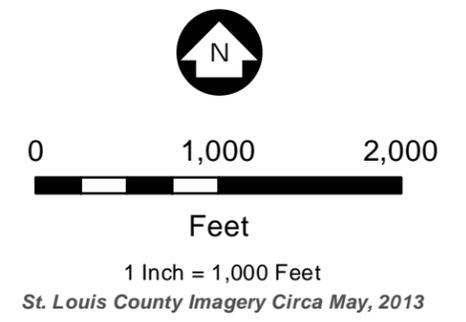

Figure 10

FLOODPLAIN
 Proposed Improvements Overview
 Spirit Mountain Recreation Area EAW
 City of Duluth
 St. Louis County, Minnesota



Barr Footer: ArcGIS 10.4.2016-05-02 15:10 File: I:\Projects\231691\657 Spirit Mountain\Maps\Reports\EAW\Figure 10 Proposed Improvements Floodplain.mxd User: mak3

Service Layer: Esri, DeLorme, Garmin, HERE, Mapbox, OpenStreetMap, P Corp., GEBCO, USGS, FAO, NPS, NRCAN, GeoBase, IGN, Kadaster NL, Ordnance Survey, Esri Japan, METI, Esri China (Hong Kong), Swisstopo, MapmyIndia, © OpenStreetMap contributors, and the GIS User Community

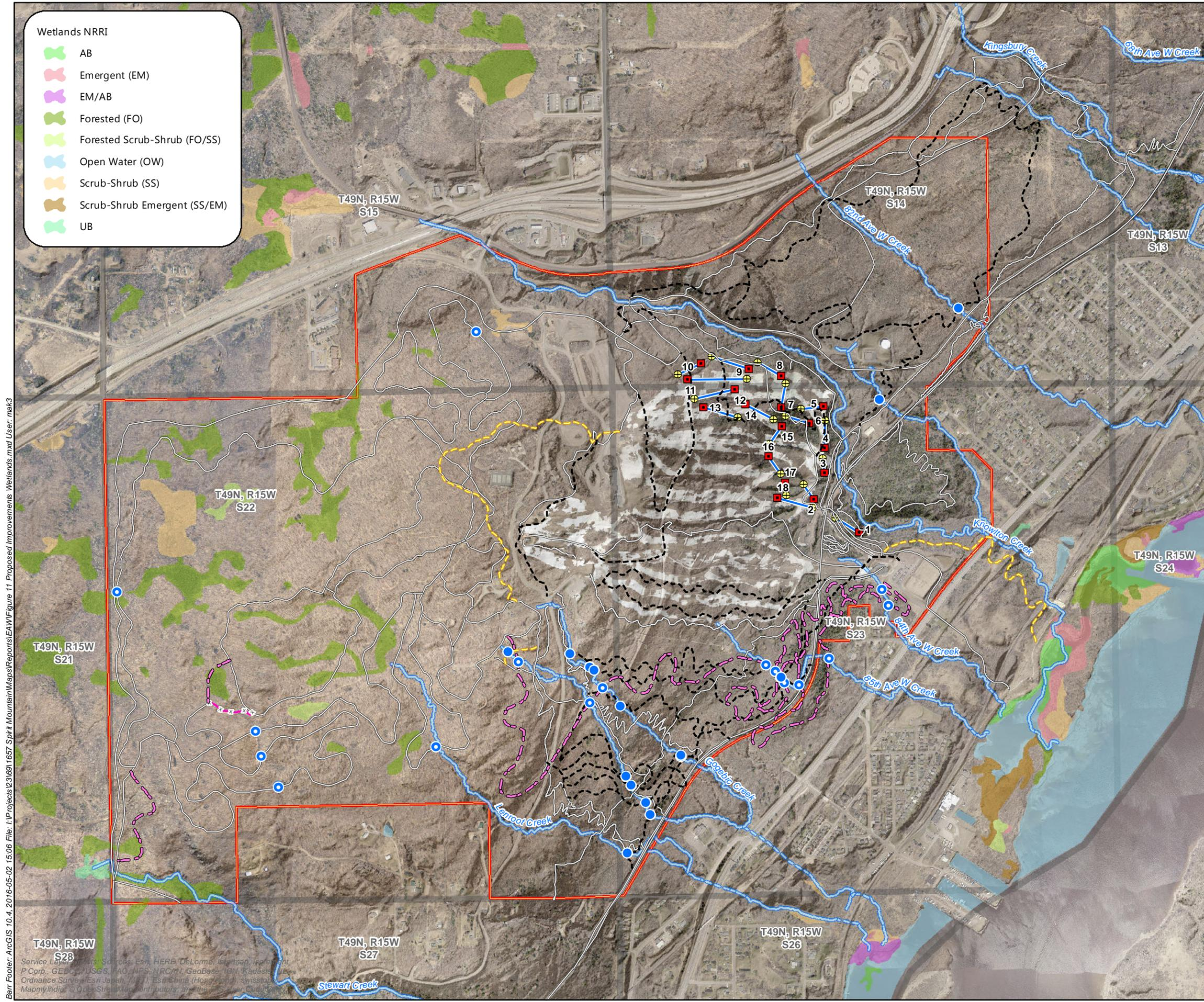

Wetlands NRRI

- AB
- Emergent (EM)
- EM/AB
- Forested (FO)
- Forested Scrub-Shrub (FO/SS)
- Open Water (OW)
- Scrub-Shrub (SS)
- Scrub-Shrub Emergent (SS/EM)
- UB

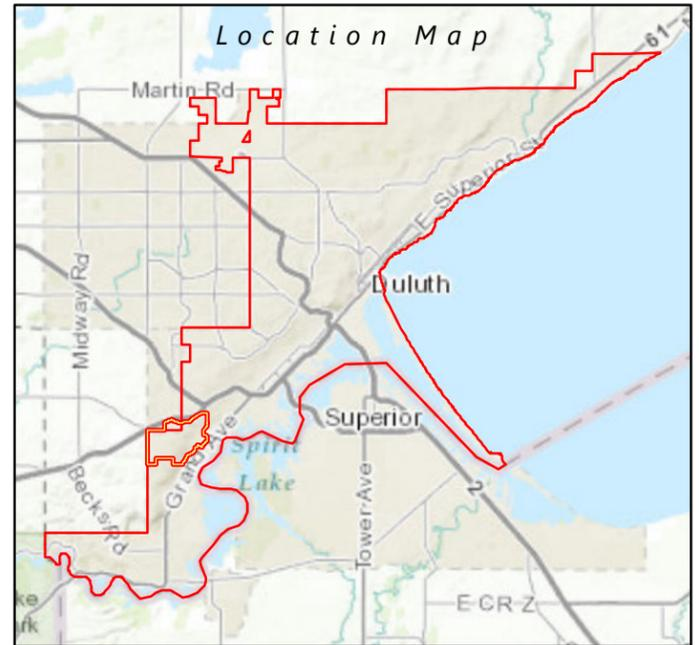

Spirit Mountain Boundary	Disc Golf Course
Proposed Bridge	Basket
Proposed Culvert	Tee Pad
Existing Trails	Course Path
Rivers and Streams	Proposed Trails
Surface Waters	Mountain Bike
Underground (Culvert)	Hiking
	Nordic Ski
	Trail to be Removed

0 1,000 2,000
 Feet
 1 Inch = 1,000 Feet
 St. Louis County Imagery Circa May, 2013

Figure 11
WETLANDS
 Proposed Improvements Overview
 Spirit Mountain Recreation Area EAW
 City of Duluth
 St. Louis County, Minnesota



Barr Footer: ArcGIS 10.4.2016-05-02 15:06 File: I:\Projects\231691657 Spirit Mountain\MapReports\EAW\Figure 11 Proposed Improvements Wetlands.mxd User: mak3

Service Layer Credits: Sources: Esri, HERE, DeLorme, Intermap, increment P Corp., GEBCO, USGS, FAO, NPS, NRCAN, GeoBase, IGN, Kadaster NL, Ordnance Survey, Esri Japan, Swisstopo, Esri China (Hong Kong), Swisstopo, MapmyIndia, © OpenStreetMap contributors, and the GIS User Community

Appendices

Appendix A

State Historic Preservation Office Determination

STATE HISTORIC PRESERVATION OFFICE

December 21, 2015

Mr. Tom Tri
Senior Environmental Scientist
Barr Engineering
325 Lake Avenue, Suite 700
Duluth, MN 55802

RE: Proposed Expansion of Recreational Facilities at Spirit Mountain Recreation Area
Duluth, Saint Louis County
SHPO Number: 2015-2872

Dear Mr. Tri:

Thank you for continuing consultation on the above project. Information received in our office on 23 November 2015 has been reviewed pursuant to the responsibilities given the Minnesota Historical Society by the Minnesota Historic Sites Act (M.S. 138.665) and the Minnesota Field Archaeology Act (M.S. 138.40).

We have completed our review of your submittal dated November 18, 2015, which included an email from Scott Anfinson regarding the potential burial mounds and a copy of the revised hiking trail plans. We are pleased that the City of Duluth has rerouted the hiking trail to avoid effects to the mound features and the archaeological sites. Therefore, we conclude that there are **no properties** listed in the National or State Registers of Historic Places, and no known or suspected archaeological properties in the area that will be affected by this project.

Please note that this comment letter does not address the requirements of Section 106 of the National Historic Preservation Act of 1966 and 36CFR800, procedures of the Advisory Council on Historic Preservation for the protection of historic properties. If this project is considered for federal assistance, or requires a federal license or permit, it should be submitted to our office by the responsible federal agency.

Please feel free to contact me if you have any concerns or questions regarding this comment letter. I can be reached at 651-259-3456 or sarah.beimers@mnhs.org.

Sincerely,

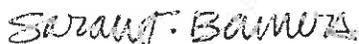

Sarah J. Beimers, Manager
Government Programs and Compliance

Appendix B

Typical Trail Designs

Winter-Use Trails



Winter trail activities have a long history in Minnesota. The extensive winter trail systems across the state allow outdoor enthusiasts ample opportunity to pursue their interests.

OVERVIEW

Winter-use trails serve a wide array of users. Although there are some common features, each trail has unique design and grooming requirements that greatly affect the user's experience.

WINTER TRAIL CLASSIFICATIONS

As defined in Section 4 – Trail Classifications and General Characteristics, a number of classifications fall under winter use trails, including:

- Cross-County Ski Trail
- Snowshoeing Trail
- Winter Hiking Trail
- Dogsledding Trail
- Skijoring Trail
- Snowmobile Trail

The following considers each of these in greater detail.

CROSS-COUNTRY SKI TRAIL

The following provides general design and grooming guidelines for cross-country ski trails. As with other types of trails, the guidelines are not intended to be a substitute for site-specific design that responds to local conditions, development requirements, and safety concerns.

CROSS-COUNTRY SKIING STYLES

Groomed cross-country ski trails typically accommodate two distinct skiing styles: Traditional/classic and skating style. Each of these styles has specific trail width and grooming requirements, as the following photos illustrate.

In traditional/classic style cross-country skiing the skier uses a kick and gliding motion to move forward within a set track – which in most park settings is machine set, as shown in this photo. In wilderness settings, the track is most often set by the lead skier “breaking” trail.

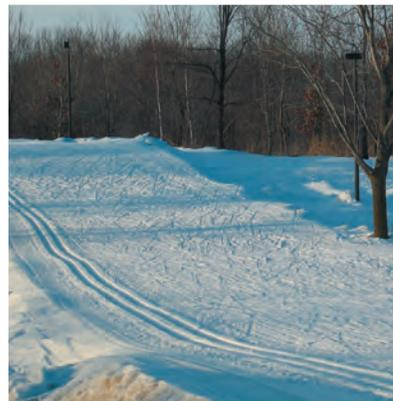
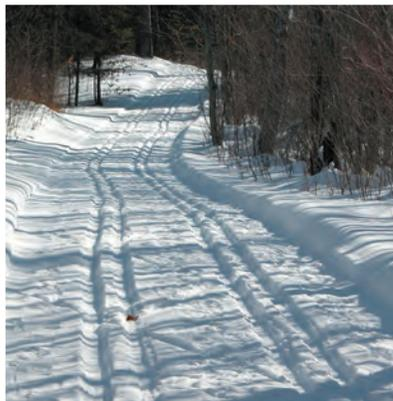

Skate skiers use a skating motion to move forward following a groomed trail surface without a track. Skating trails are almost always machine groomed, as shown in this photo (to the right of the set traditional track).

TRAIL TREAD WIDTHS AND CONFIGURATIONS

The physical space required for the two styles of skiers provides the base-line for determining the optional width for cross-country trails. The configuration of trails also affects the width of the trail, as the following graphic illustrates.

TYPICAL TRAIL WIDTHS FOR CROSS-COUNTRY SKI TRAILS

Trail widths vary considerably to accommodate the two styles of skiing. The following defines the basic trail widths and directional configurations for each type of cross-country ski trail commonly found in Minnesota. (These correspond with the cross-country ski trail configurations defined in Section 4 – Trail Classifications and General Characteristics.)



Generally used in a casual park setting or trails in less frequently used county, regional, and state parks. Grooming is limited and trails are often tracked by local users. One direction is used where use levels are higher, otherwise direction of use is often informal and two way.

Traditional (Classic) Style - One Track Set/One or Two Direction



The most common type of groomed trail in many state parks and less frequently used regional or county parks. Routinely groomed, especially after a snowfall of a couple inches or more. One direction is used on busy and/or more challenging trails. Otherwise, two-way trail is most common.

Traditional (Classic) Style - Two Track Set/One or Two Directions



Occasionally used in county, regional, or state parks where use pressures are high and/or where separation of skiing styles is preferred. Also occasionally used as a connector trail from one loop to the next.

Skate Style - Single Width/One Direction



Occasionally used in county, regional, or state parks where use pressures are high and/or where separation of skiing styles is preferred.

Not as common as combination trails due to increased kilometers of trails needed to accommodate separated uses, and the additional time needed to groom the trails.

Skate Style - Double Width/One or Two Directions

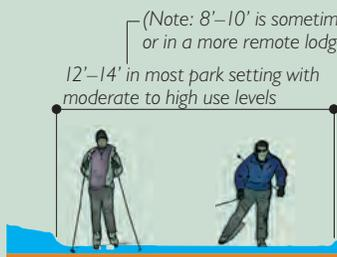

One directional use helps avoid confusion and conflict and keeps overall tread width a bit narrower.

Combination Traditional and Skate Style - One Direction

The most common trail configuration in county, regional, and state parks where both styles of skiing are accommodated. Suitable for moderate to high use levels.



Also used as a linear connector between loops where two-direction use must be accommodated.

Combination Traditional and Skate Style - One or Two Directions

This trail width is generally used in transition areas, near a trailhead, and where use levels are very high and more maneuvering space is needed for skiers.

The trail widths as shown in the graphic are general and are often modified to accommodate site-specific conditions. For example, trail widths are often increased on steep hills to allow skiers to herringbone up or snowplow down, or to provide adequate space at the bottom of a slope for run-outs. Long uphill may also require extra width to allow moving skiers to pass resting ones. Trailhead areas and trail intersections and transition zones where skiers often congregate often warrant wider trails to avoid congestion. At busier trails, consider providing a wider trail for the first 1/4 to 1/2 kilometer from the trailhead to allow skiers to spread out and let faster skiers get past slower ones. The following photos illustrate a variety of situations where widening the trail has merit.



This short but steep hill climb has been widened by grooming equipment (and use) to allow faster skiers to pass slower ones without crossing skis. Notice how the track on the right ceases to exist since traditional style skiers tend to use a herringbone stride to get up the hill. Too narrow of a trail up a hill this steep can be very annoying to skiers. This segment is about 16 feet wide.



This longer hill "grind" forces many skiers to take a break part way up. Without some extra width, a hill like this can become congested quickly as resting, traditional, and skate skiers all jockey for position to avoid losing momentum. In these cases, the groomed part of the trail should be wide enough for a skate skier to pass another skier doing a herringbone maneuver. This segment is about 16 feet wide.



This uphill section does not require much trail widening since it is gentle and short enough for either style of skier to maintain form and make it up with relative ease. This segment retains the recommended 12- to 14-foot width.

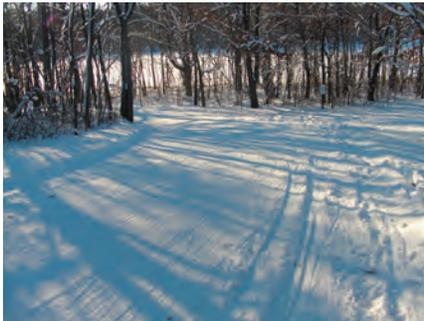

Although not excessively steep, this downhill run warrants a slightly wider run-out area on the right side since it transitions quickly into a sharp curve with trees on the outside of it. Note the loss of the track as skiers break their speed using a snowplow maneuver. It only takes one snowplow to wipe out the track, forcing all that follow to also snowplow, thereby compounding the problem.



Trails are commonly widened at intersections since it is common for skiers to stop and decide on which direction to go and/or catch their breath. These areas should be wide enough to allow through-skiers to continue on unimpeded.



On this steeper uphill section, this two-track traditional trail only widens a foot or two to accommodate herringbone or snowplowing skiers. With light levels of use, there is no reason to make the trail wider on a hill.

Make sure clearance of brush takes snow load into consideration!

Brushy material that might hang into the trail once it gets loaded with snow should also be removed when the trail is being prepared for the ski season.

TRAIL CLEARANCE ZONES

The clearance zone is defined as the physical space above and on either side of the trail that is free from obstructions. A 10-foot vertical clear area is recommended for all ski trails. This clear zone is especially important and may have to be enlarged when larger grooming equipment is used. The vertical clearance zone should also take into consideration the depth of the snow since the grooming equipment will sit on top of it.

The horizontal clearance zone should extend a minimum of 24 inches on either side of the groomed area to provide enough extra space for a skier's pole or ski to occasionally flail out and not catch on brush and tree limbs. It also provides more space for the grooming equipment to maneuver. The horizontal clearance zone should also increase around corners at the base of a hill where skiers are most likely to fall or go off the trail and catch a ski on brush or run into a tree. The extent to which this should occur is a matter of site-specific evaluation. The following photos illustrate common clearance zones adjacent to ski trails.

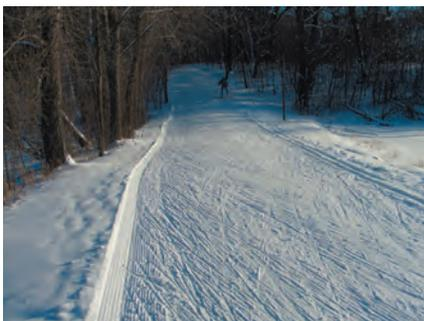

This is a common example of a comfortable clearance zone adjacent to a groomed and tracked trail. The clearance zone is especially important where trees and brush are present on downhill runs.

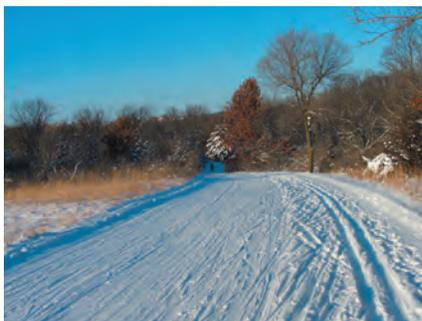

In grassy areas, the clearance zone is less obvious and less important since this type of vegetation is less likely to catch a pole or ski and skiers are less likely to be injured if they ski off the trail.



This two-track traditional trail through the woods is nicely groomed and has appropriate clearance zones for a pleasant experience.

TRAIL GRADES, CURVES, AND SIGHT DISTANCES

Cross-country ski trails should provide a variety of terrain consistent with the desired difficulty level. As a general rule, one-third of a given trail should be uphill, one-third should be downhill, and one-third should be undulating or rolling grade. The height and steepness of uphill and downhill should be consistent with the trail difficulty rating as described in Section 4 – Trail Classifications and General Characteristics and the guidelines in the following table.

CROSS-COUNTRY TRAIL GRADE GUIDELINES

The table provides general guidelines for trail grades relative to trail difficulty ratings associated with general use cross-country ski trails.

Aspect	Easy	Intermediate	Expert/Advanced
Avg. trail grade	4%–10%	6%–12%	> 12% (most challenging loops)
Max. hill grade	10%–12%	12%–18%	> 18, with 40% max. for short distance
Avg. total climb per km	10–15 m/30–50 ft	15–25 m/50–80 ft	25–35 m/80–115 ft
Max. hill height	10–30 m/30–100 ft	30–50 m/100–165 ft	50–80 m/165–260 ft

Combining easier and more difficult trails!

Note that a trail cutoff can be used to bypass challenging hill climbs or descents. This allows an otherwise expert trail to be used as part of an easier or intermediate trail loop.

The maximum hill height and grade are important considerations in trail design in that most skiers are not experts and can become frustrated (and less likely to return) if the trails are consistently too difficult. As defined in Section 4, easy to intermediate trails should make up the core system of trails, with expert level trails being “stacked” onto these trails. For beginning skiers, an average gradient of 4 percent is preferred across a pleasant, undulating terrain. Climbs should be less than 10 meters in height at a maximum grade of 9 percent.

Even on more difficult trails, steeper and longer climbs should be broken up with short, level sections for brief resting areas. This is especially the case on easy trails, where anything above 10 percent can be too challenging to negotiate for recreational skiers. As common practice, steep uphill should be kept to a minimum on all but advanced trails since relatively few skiers have the skills and stamina to really enjoy them.

DOWNHILLS

The design of downhill runs is especially important with cross-country ski trails. In general, the longer and steeper the run, the straighter and longer the run-out area needs to be at the bottom of the hill. As a general guideline, the run-out should be at least as long as the slope in order to dissipate speed and allow a skier to regain any loss of control before a sharp curve or another downhill section. If space is limited, a rise in grade at the bottom of the slope can be used to offset the loss of run-out distance. Also, the clearance zone along and at the bottom of a downhill run should be ample enough to allow a skier to fall and slide off-trail several feet without running into a tree or heavy brush. Long downhill should also be avoided on most trails since the average skier is not comfortable with excessive speed.

On two-direction trails, the trail should be wide enough to completely separate uphill and downhill skiers when trail grades exceed 8 to 10 percent. This can be accomplished by widening the trail or by providing separate trails for uphill and downhill skiers.

CURVES

Since most skiers are not experts and are likely to lose control from time to time, sharp curves at the bottom of a hill should simply be avoided. “Sharp” is defined as any curve radius that is tight enough where the average skier can be thrown off-balance. As a general guideline, a radius of 100 feet or more is preferred, with 50 feet being the minimum on non-hill sections of the trail. For tracked trails, average skiers should be able to stay in the groomed track as they proceed down the slope. Average skiers should not have to rely upon a snowplowing technique to proceed down a slope on a recreational-level ski trail.

If a curve is needed through a downhill section, it should be as long and gentle as possible to avoid throwing the skier off balance. Widening the trail and adding additional clearance on the outside of the curve should also be considered to provide enough space for out-of-control skiers to regain their stride, or to fall and slide a few feet outside the groomed trail. A widened trail also provides more space for advanced skiers to pass slower ones through these sections with greater ease. In situations where a curve at the end of a downhill cannot be avoided, a warning sign at the top of the slope should be provided, typically about 100 feet before the beginning of the slope.



This long downhill is made easier by having open sightlines and enough undulations to slow skiers and help them avoid excessive speeds and loss of control.

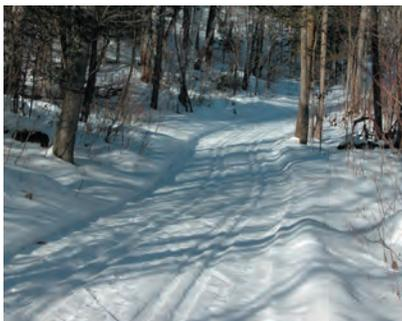

The gentle curve of this trail controls sightlines and piques skiers' interest about what is around the corner. Juxtaposition of longer sightlines with intimate spacing using curves is appealing to skiers.

Although curves through downhills should be carefully considered, taking all of the challenge out of a ski trail by making it too straight, uninteresting, and less challenging should also be avoided. For high-level trails, curves through a downhill can be part of the desired experience as long as reasonable precautions are taken with run-out area and clear zones. An alternative approach is to provide a bypass around a more difficult section that allows skiers to choose the level of challenge best suited to their skill level. A well-placed bypass could be a de facto run-out that allows even more advanced skiers to “bail out” if they misjudge the curve. Signage is recommended in these instances to alert skiers to the options.

Where curves are provided through or at the base of a downhill, a modest superelevation may have merit to keep skiers in the set track. Since this often allows skiers to go faster, providing an adequate run-out and clearance area on the outside of the curve remains an important safety consideration. A maximum superelevation of 4 or 5 percent is recommended.

SIGHT DISTANCES

Although not as critical as some types of trails, reasonable sight distances should still be provided along a ski trail. As a general guideline, a sight distance of 100 feet is optimal, especially through sharp curves or downhill sections. The recommended minimum is 50 feet to ensure that skiers can see and react to approaching trail conditions.

The following photos illustrate a variety of trail grades, curve situations, and sightlines encountered on cross-country ski trails.



This gentle curve through a long but not too steep downhill is fun and skiers can stay in control. The long run-out at the bottom provides a nice, slightly uphill transition into another downhill segment.



The approach to this short but steep hill section is long and straight, allowing a skier to build momentum for the climb.



Skiers can readily see the trail ahead as they descend along this modest downhill. The curvilinear character of this trail through the woods adds to its appeal.



Managing sightlines can add excitement to a ski trail experience. In this photo, skiers get a hint of what is to come, yet the full scene is not exposed until they reach the corner and the view of a riverway is framed by the rock outcrops.

TREAD PREPARATION

The tread refers to the underlying trail beneath the compacted and groomed snow. Proper off-season evaluation of trail alignments and tread surface preparation and maintenance is critical to setting the stage for quality cross-country ski trails. The following considers the most important aspects of preparing the tread for winter use.

TRAIL ALIGNMENT

Section 4 – Trail Classifications and General Characteristics, considered cross-country trail alignment in terms of laying out a system of trails with varying levels of difficulty. In the context of the tread surface, alignment refers to locating trails where snow will remain the longest and be most stable. One of the biggest factors in this regard is sun intensity, especially later in the season when the sun begins to build strength and more quickly melts the snow surface in exposed areas.



Hardwood forests help shield the trail from sun, which helps extend the season. The only downside is that maintaining a grass ground cover can be more challenging in the summer for the same reason – especially if the trail is also used for summer hiking. Limiting summer access or using an alternative surface, such as woodchips, are possible solutions.



Excessive pine needles dropping on the trail can be very annoying to skiers. Where this is a persistent problem, the trail corridor may have to be selectively opened up or the trail rerouted to a less problematic corridor.

Hardwood forests are usually well suited for ski trails because the sun is less intense and the air temperature is slightly colder than open areas. Using changes in topography to reduce the extent of direct sun on the trail can also be an effective strategy. This is especially the case along the base of north-facing slopes where the sun is usually less intense relative to wide-open flat areas. Avoid locating ski trails along the base of south facing slopes whenever possible since the sun tends to be the most intense in these areas, especially in open settings.

Running a trail through a coniferous forest also poses some problems with pine needles and cones dropping on to the trail and sticking to the skis, thereby slowing down the skier. Where this situation cannot be avoided, the clearance zone may have to be widened to prevent excessive needle accumulation on the trail.

In open, shortgrass prairie areas, wind can strip snow from or deposit drifting snow on the trail, both of which make for poorer skiing conditions and require more frequent grooming. Before a trail is permanently established, potential alignments in wind-swept areas should be field tested over one or two seasons to determine seasonal wind effects and snow displacement patterns. Even relatively minor shifts in the location of a ski trail can make a dramatic difference in the impact wind will have on it.

In tallgrass prairies, wind and sun are less of a concern since the grasses are high enough to shade the trail and reduce sun exposure. As with shortgrass prairies, field testing the alignment of a trail over one or two seasons can be beneficial to determining the most advantageous location to hold snow.

TREAD CHARACTERISTICS

The trail tread is another major consideration in the development of quality ski trails. The cross-section, trail surface, summer uses, and erosion are all reflected in the groomed surface of the trail and factor into overall trail quality.

Trail Cross Grades

The optimal ski trail cross-section is of a consistent, even grade with a 0 to 2 percent cross-slope, as illustrated in the following graphic.

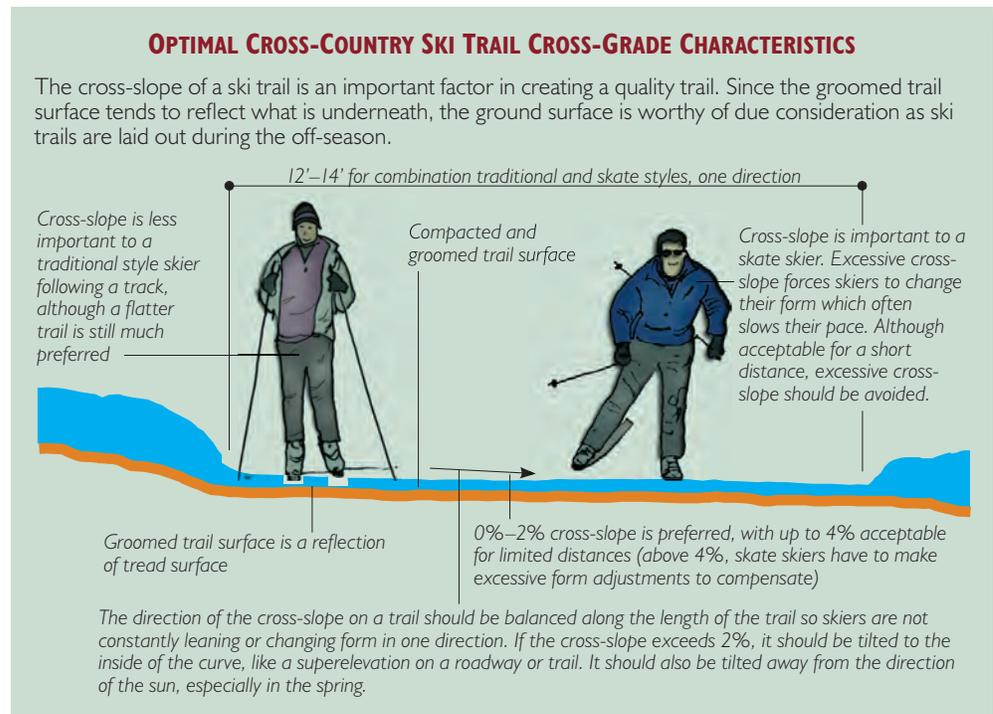

As illustrated, an evenly sloped grade across the trail is important to both styles of skiers in order to maintain an optimal skiing form. Abrupt grade changes or general unevenness across a trail should be also avoided to make trails easier to groom and more enjoyable to ski on. The following two graphics illustrate these conditions.

ABRUPT TREAD CROSS GRADES

Abrupt trail cross grades negatively affect the form of both styles of skiers, depending on the degree to which it occurs and the skill of the skier. While more advanced skiers can more easily compensate for grade changes in their form, novice and recreational skiers can find it frustrating.

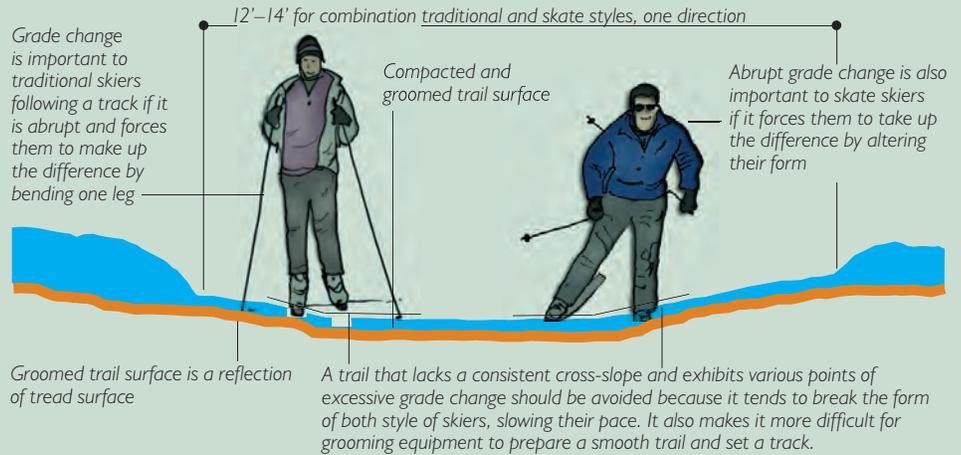

EXCESSIVE TRAIL UNEVENNESS

Excessive trail unevenness negatively affects the form of both styles of skiers. It also requires more snow to establish a base. Although good grooming technique can smooth out some of the rough spots on the tread surface, excessively uneven areas should be avoided because they can be more prone to washboarding and thin spots.

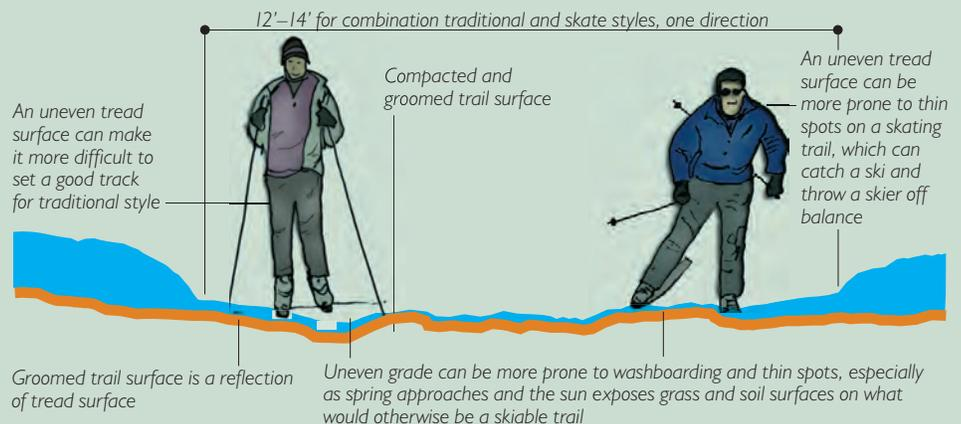

The following photos illustrate some of the previously described cross-section conditions.



The nice even trail tread with a slight cross-slope is well suited for a two-track set through the woods, making for easy grooming and fun skiing.



The cross-slope on this trail (arrow) is greater than desired but is not a major issue because it is only for a short distance. If this went on for a distance, skiers would find it annoying.



Even these simple ruts unintentionally caused by maintenance vehicles can cause an uneven surface that may be reflected in the ski trail, annoying both groomers and skiers.

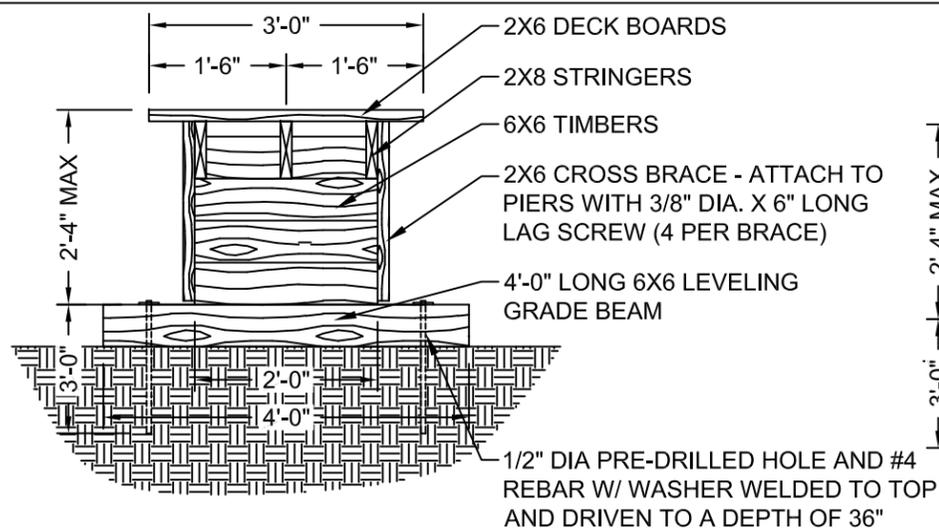

36" WIDE BOARDWALK
NOT TO SCALE

1/2

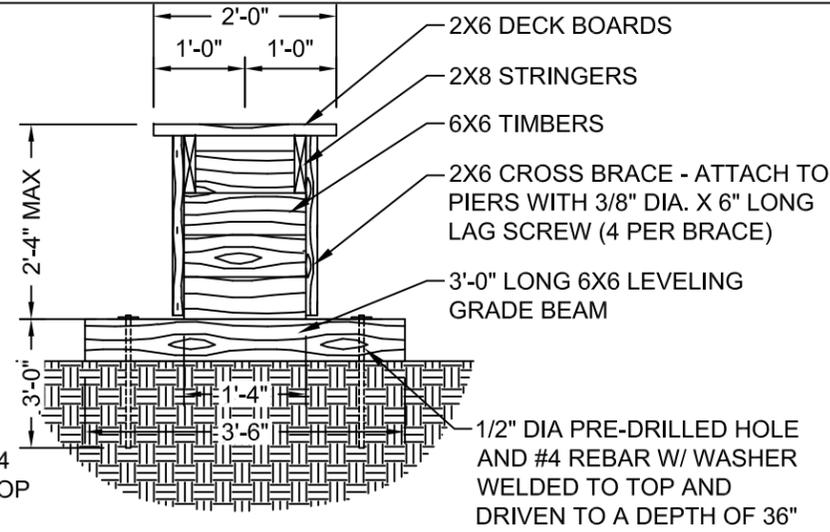

24" WIDE BOARDWALK
NOT TO SCALE

2/2

EDGE OF BOARDS MAY BE ALIGNED, HAVE SLIGHT CURVE, OR PLACED ERRATICALLY, (LENGTH OF BOARD WILL NOT CHANGE)

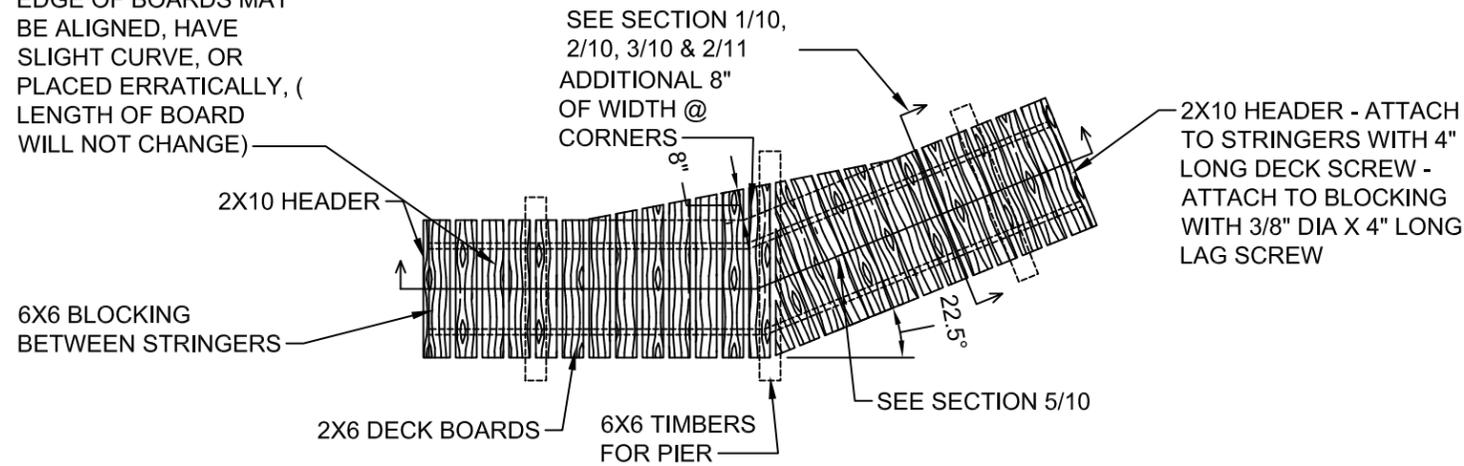

TYPICAL PLAN DETAIL OF BRIDGE (36" WIDE SHOWN)
NOT TO SCALE

3/2

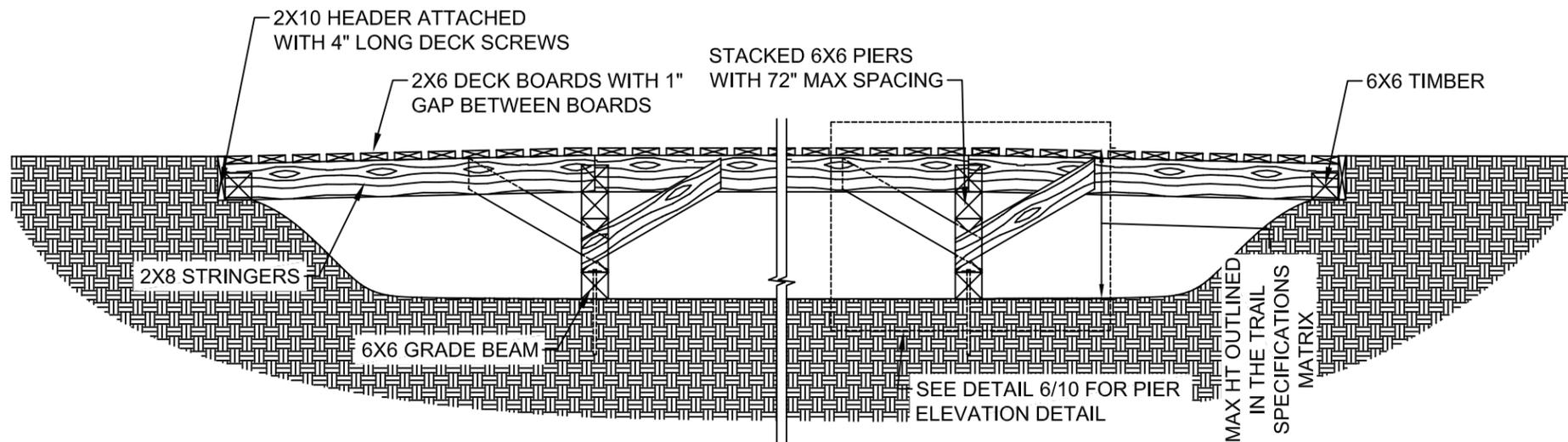

TYPICAL ELEVATION DETAIL FOR BOARDWALK (WET AREA CROSSINGS)
NOT TO SCALE

4/2

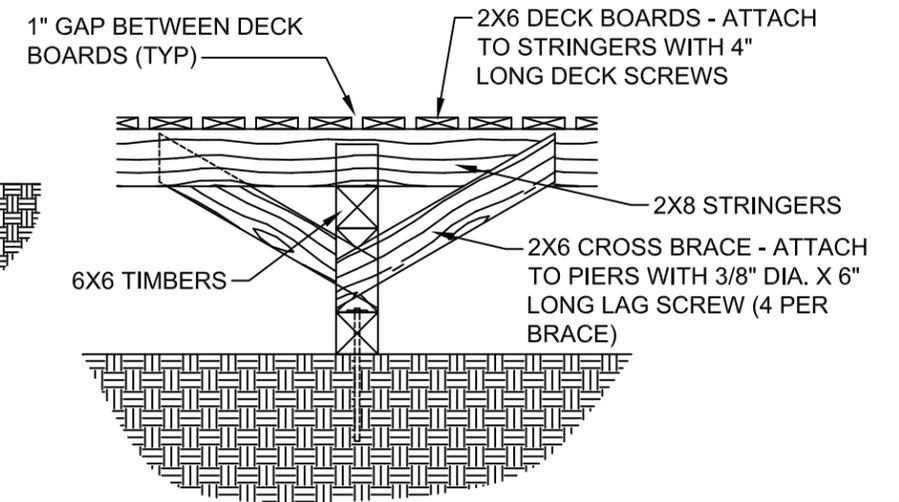

TYPICAL ELEVATION @ PIER LOCATION
NOT TO SCALE

5/2

DETAIL NOTES:

1. FINAL BOARDWALK FIELD DESIGN IS THE RESPONSIBILITY OF THE CONTRACTOR AND SHALL BE BASED ON THE ENGINEERED CONSTRUCTION DOCUMENTS HEREIN AND IN THE SPECIFICATIONS.
2. CONTRACTOR IS TO PROVIDE A TYPICAL BOARDWALK AND BRIDGE SHOP DRAWING THAT IS PLANNED TO BE CONSTRUCTED IN THE FIELD FOR APPROVAL BY THE LANDSCAPE ARCHITECT.
3. LUMBER SHALL BE SIZED TO THE FULL DIMENSIONS SHOWN ON THE PLANS UNLESS NOTED OTHERWISE. ALL LUMBER SHALL BE A ROT-RESISTANT SPECIES OR TREATED ACCORDING TO THE OPTIONS INDICATED IN THE SPECIFICATIONS.
4. ACCEPTABLE MATERIALS FOR THE DECK RIDING SURFACE MUST BE ROUGH CUT LUMBER AND INCLUDES: CEDAR, TAMARACK AND TREATED PINE. ALL OTHER LUMBER USED IN THE CONSTRUCTION CAN BE EITHER ROUGH CUT OR DIMENSIONAL TREATED PINE LUMBER.
5. ROT-RESISTANT TREATMENTS OTHER THAN THOSE LISTED MUST BE APPROVED BY THE LANDSCAPE ARCHITECT PRIOR TO BIDDING.
6. LEVELING GRADE BEAMS SHALL BE SHIMMED AS NECESSARY TO MEET DESIRED PITCH OF STRUCTURE AND ANCHORED TO THE GROUND WITH A MINIMUM OF 36" LONG #5 REBAR DRIVEN THROUGH A PRE DRILLED HOLE IN THE TIMBER.
7. SELECT FASTENERS AND HARDWARE IN ACCORDANCE WITH THE SPECIFICATIONS
8. SIZES, LENGTHS AND EXTENT OF ALL BOARDWALKS, ROCK HARDENED TREAD, BRIDGES AND BERMS TO BE FIELD FIT AT TIME OF CONSTRUCTION.
9. BOARDWALK & BRIDGE CONSTRUCTION LOCATIONS WILL BE DETERMINED IN THE FIELD BY THE CONTRACTOR AND SUBMITTED TO THE OWNER FOR APPROVAL.
10. CUT BRUSH AND SLASH MUST BE DISPOSED IN AN UPLAND LOCATION AND MUST BE KEPT OUT OF STREAMS, GULLIES, SWALES, WET AREAS, AND LOW AREAS. SEE SPECIFICATIONS FOR DETAILS.
10. NO EXCAVATION OR FILL PERMITTED IN WET AREAS. IT IS THE RESPONSIBILITY OF THE CONTRACTOR TO CONSULT WITH THE OWNER PRIOR TO DOING ANY WORK WITHIN SUSPECTED WET AREAS.
11. WOOD RAMPS OR STONE PITCHING MAY BE REQUIRED BEFORE AND AFTER BRIDGES AND BOARDWALKS. APPLICATION WILL BE DETERMINED IN THE FIELD, BY THE CONTRACTOR AND MUST BE APPROVED BY THE OWNER PRIOR TO CONSTRUCTION. PAYMENT FOR RAMPS WILL BE ADDED TO THE TOTAL LENGTH OF THE BOARDWALK AND PAYMENT FOR STONE PITCHING WILL BE PER THE UNIT BID PRICE OF ROCK ARMORING.

DETAIL NOTES:

1. FINAL BOARDWALK FIELD DESIGN IS THE RESPONSIBILITY OF THE CONTRACTOR AND SHALL BE BASE ON THE ENGINEERED CONSTRUCTION DOCUMENTS HEREIN AND IN THE SPECIFICATIONS.
2. CONTRACTOR IS TO PROVIDE A TYPICAL BOARDWALK AND BRIDGE SHOP DRAWING THAT IS PLANNED TO BE CONSTRUCTED IN THE FIELD FOR APPROVAL BY THE LANDSCAPE ARCHITECT.
3. LUMBER SHALL BE SIZED TO THE FULL DIMENSIONS SHOWN ON THE PLANS UNLESS NOTED OTHERWISE. ALL LUMBER SHALL BE A ROT-RESISTANT SPECIES OR TREATED ACCORDING TO THE OPTIONS INDICATED IN THE SPECIFICATIONS.
4. ACCEPTABLE MATERIALS FOR THE DECK RIDING SURFACE MUST BE ROUGH CUT LUMBER AND INCLUDES: CEDAR, TAMARACK AND TREATED PINE. ALL OTHER LUMBER USED IN THE CONSTRUCTION CAN BE EITHER ROUGH CUT OR DIMENSIONAL TREATED PINE LUMBER.
5. ROT-RESISTANT TREATMENTS OTHER THAN THOSE LISTED MUST BE APPROVED BY THE LANDSCAPE ARCHITECT PRIOR TO BIDDING.
6. LEVELING GRADE BEAMS SHALL BE SHIMMED AS NECESSARY TO MEET DESIRED PITCH OF STRUCTURE AND ANCHORED TO THE GROUND WITH A MINIMUM OF 36" LONG #5 REBAR DRIVEN THROUGH A PRE DRILLED HOLE IN THE TIMBER.
7. SELECT FASTENERS AND HARDWARE IN ACCORDANCE WITH THE SPECIFICATIONS
8. SIZES, LENGTHS AND EXTENT OF ALL BOARDWALKS, ROCK HARDENED TREAD, BRIDGES AND BERMS TO BE FIELD FIT AT TIME OF CONSTRUCTION.
9. BOARDWALK & BRIDGE CONSTRUCTION LOCATIONS WILL BE DETERMINED IN THE FIELD BY THE CONTRACTOR AND SUBMITTED TO THE OWNER FOR APPROVAL.
10. CUT BRUSH AND SLASH MUST BE DISPOSED IN AN UPLAND LOCATION AND MUST BE KEPT OUT OF STREAMS, GULLIES, SWALES, WET AREAS, AND LOW AREAS. SEE SPECIFICATIONS FOR DETAILS.
10. NO EXCAVATION OR FILL PERMITTED IN WET AREAS. IT IS THE RESPONSIBILITY OF THE CONTRACTOR TO CONSULT WITH THE OWNER PRIOR TO DOING ANY WORK WITHIN SUSPECTED WET AREAS.
11. WOOD RAMPS OR STONE PITCHING MAY BE REQUIRED BEFORE AND AFTER BRIDGES AND BOARDWALKS. APPLICATION WILL BE DETERMINED IN THE FIELD, BY THE CONTRACTOR AND MUST BE APPROVED BY THE OWNER PRIOR TO CONSTRUCTION. PAYMENT FOR RAMPS WILL BE ADDED TO THE TOTAL LENGTH OF THE BOARDWALK AND PAYMENT FOR STONE PITCHING WILL BE PER THE UNIT BID PRICE OF ROCK ARMORING.

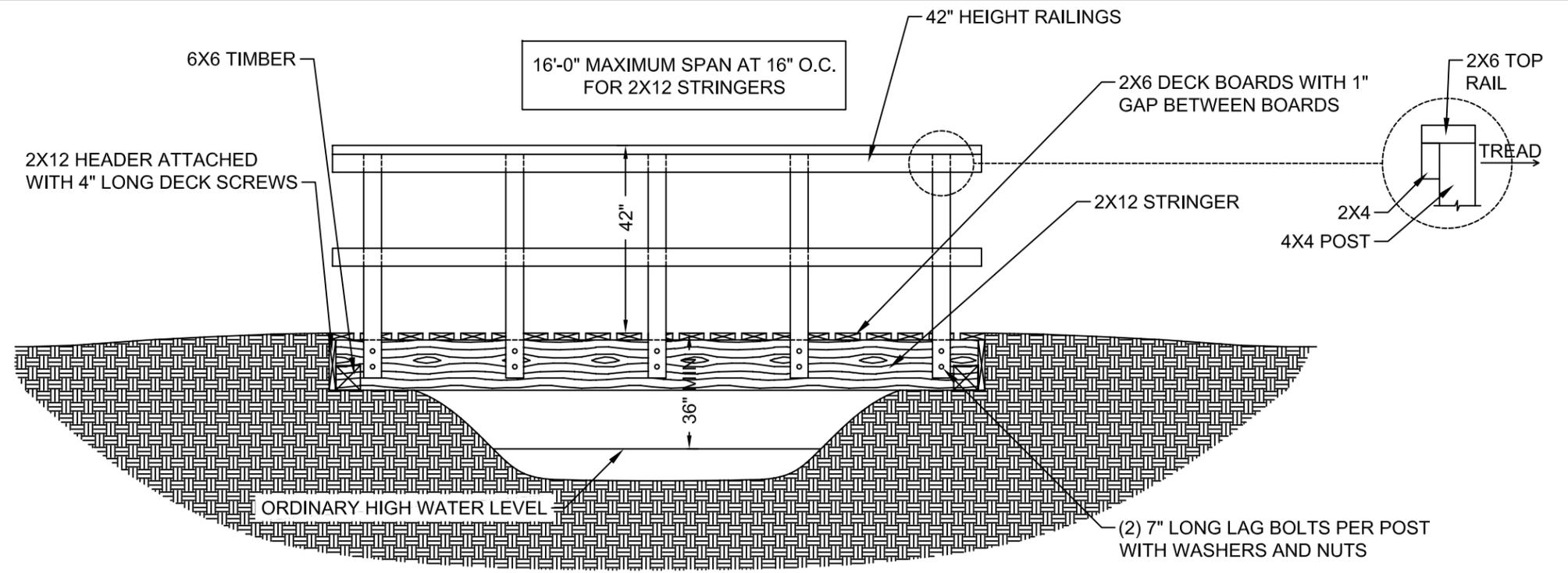

TYPICAL ELEVATION DETAIL FOR BRIDGE (CREEK CROSSINGS)

NOT TO SCALE

2/2

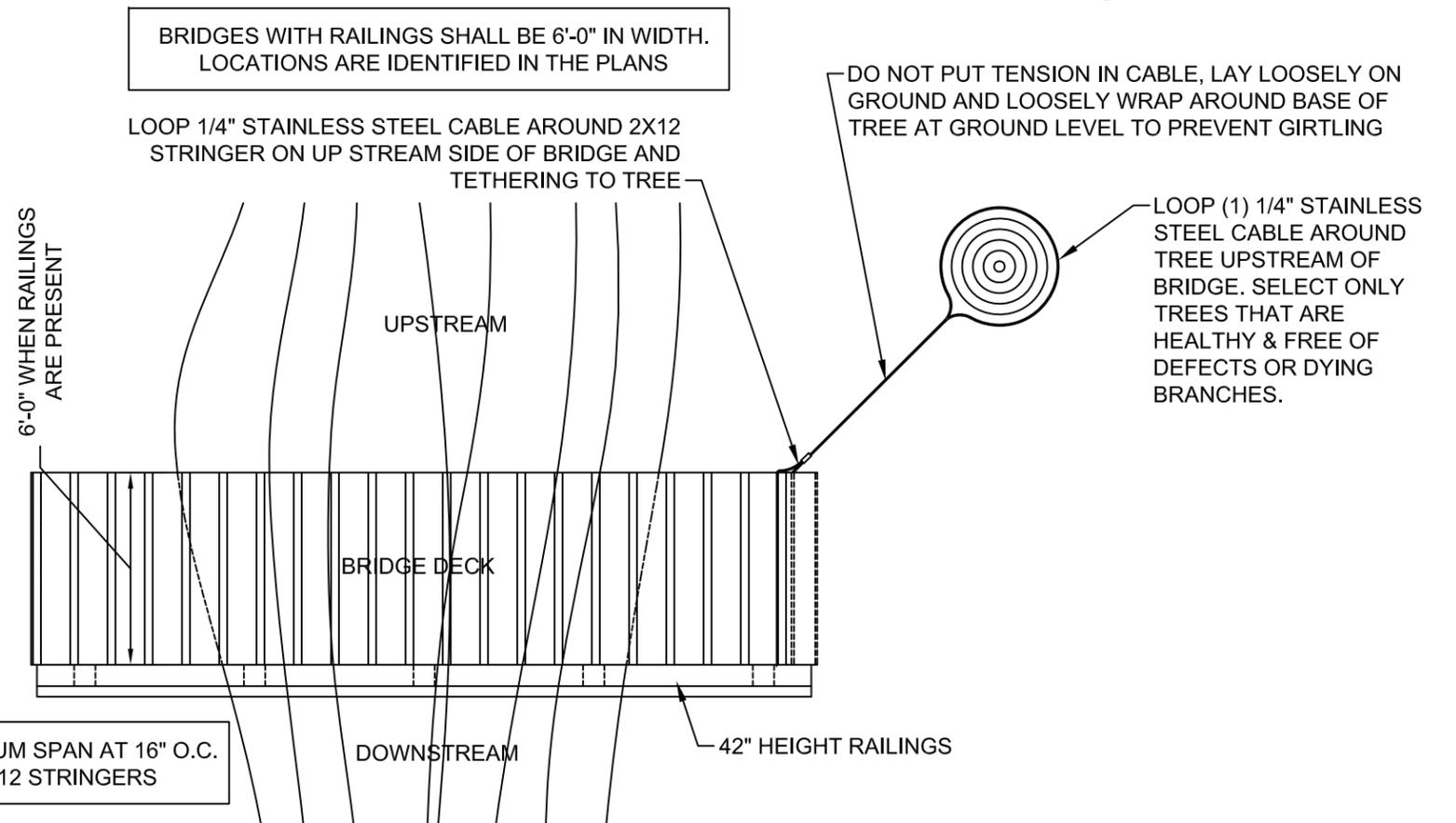

TYPICAL PLAN DETAIL FOR BRIDGE (CREEK CROSSINGS)

NOT TO SCALE

2/2

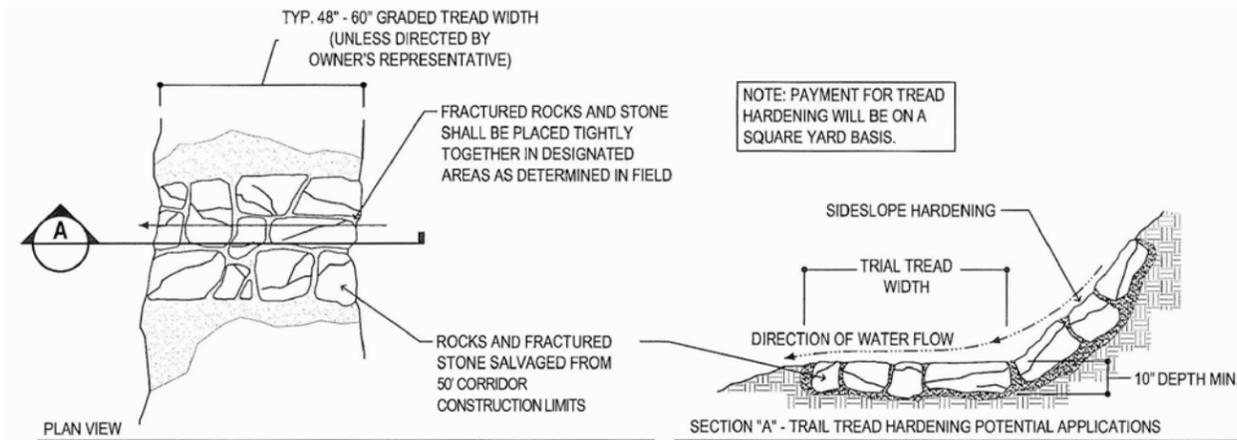

CONSTRUCTION NOTE:

BACKFILL BEDDING MATERIAL SHALL BE 3"- 6" OF 3/4" - CRUSHED ROCK. THE SAME CRUSHED ROCK CAN BE UTILIZED FOR FILL BETWEEN THE SET ROCK/STONE.

10" MINIMUM ROCK/STONE SET DEPTH.

SEAMS RUNNING IN THE DIRECTION OF TRAVEL SHALL BE MINIMIZED IN BOTH LENGTH AND WIDTH. SEAM WIDTH SHALL BE MINIMIZED AND SEAM STAGGERING SHALL BE USED WHERE POSSIBLE.

- SWPPP NOTES:**
1. ALL DISTURBED AREAS NOT PART OF ACTIVE TREAD TO BE STABILIZED WITHIN 7 DAYS OF NOT BEING WORKED. SEE (SWPPP) STORM WATER POLLUTION PREVENTION PLAN FOR DETAILS.
 2. WHENEVER POSSIBLE USE NATIVE DUFF MATERIALS FOUND IN THE TRAIL CORRIDOR AS A MULCH FOR COVERING SOIL EXPOSED BY BACKSLOPE AND DOWNSLOPE CUTS. WOOD CHIPS MADE FROM WOODY MATERIAL CLEARED AS A RESULT OF THE CORRIDOR CLEARING ARE AN ACCEPTABLE ALTERNATIVE TO NATIVE DUFF MULCH.
 3. FOR SLOPE ANGLES UNDER 3:1 USE TEMPORARY EROSION CONTROL SEED MIX AND FOR DISTURBED AREAS THAT ARE LACKING ADEQUATE NATIVE DUFF MATERIAL.
 4. FOR SLOPE ANGLES 3:1 AND OVER USE PERMANENT EROSION CONTROL SEED MIX AND EROSION CONTROL BLANKET FOR LAND SLIDE AREAS AND AREAS OF HEAVY DISTURBANCE. THESE AREAS MUST BE APPROVED BY THE OWNER.
 5. SEE SWPPP FOR SEED MIX DETAILS.
 6. AFTER COMPLETION OF ALL GRADING, THE TRAIL TREAD SHALL BE MECHANICALLY COMPACTED TO ITS SPECIFIED WIDTH USING A VIBRATORY PLATE, SHEEP'S FOOT, OR OTHER APPROVED EQUAL COMPACTOR.
 7. CUT BRUSH AND SLASH MUST BE DISPOSED IN AN UPLAND LOCATION AND MUST BE KEPT OUT OF STREAMS, GULLIES, SWALES, WETLANDS, AND LOW AREAS. SEE SPECIFICATIONS FOR DETAILS.
 8. NO EXCAVATION OR FILL PERMITTED IN WET & LOWLAND AREAS. IT IS THE RESPONSIBILITY OF THE CONTRACTOR TO CONSULT WITH THE OWNER PRIOR TO DOING ANY WORK WITHIN SUSPECTED WET & LOWLAND AREAS.

TRAIL TREAD ROCK ARMORING AND SIDESLOPE ARMORING DETAIL

NOT TO SCALE

1/3

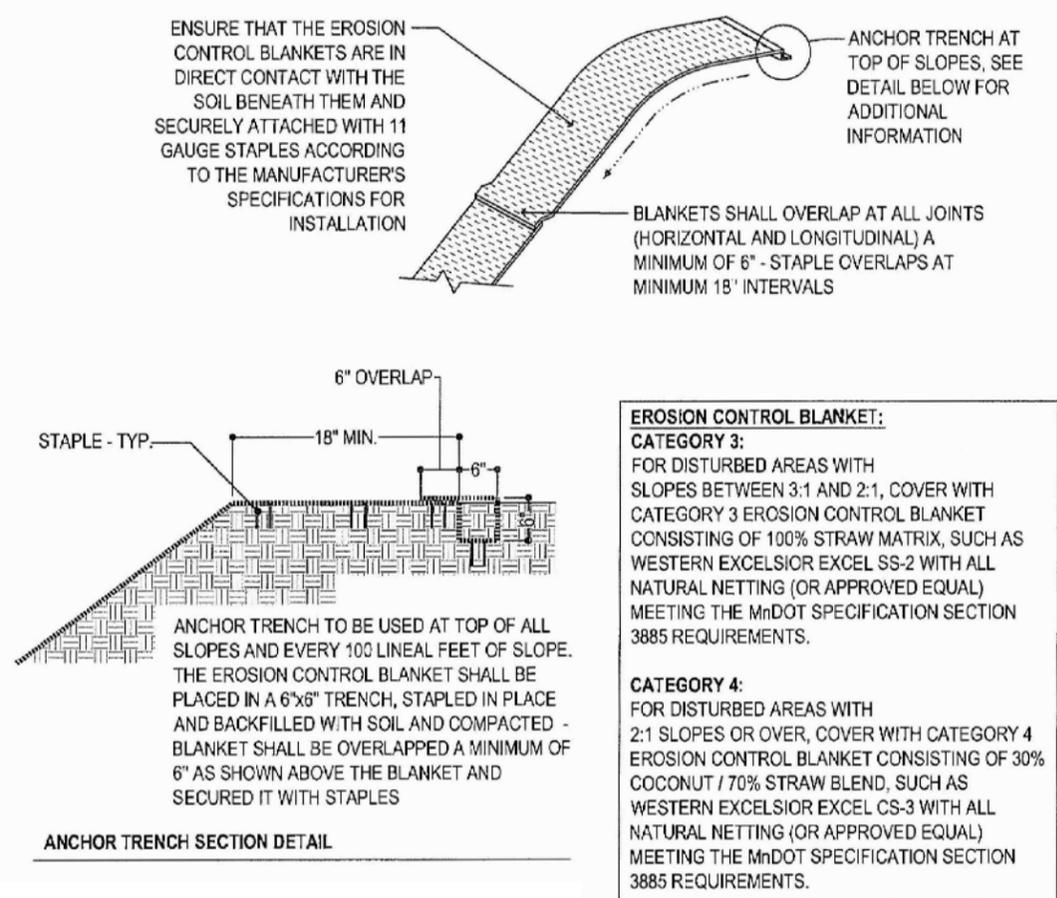

WOOD FIBER BLANKET DETAIL

NOT TO SCALE

2/3

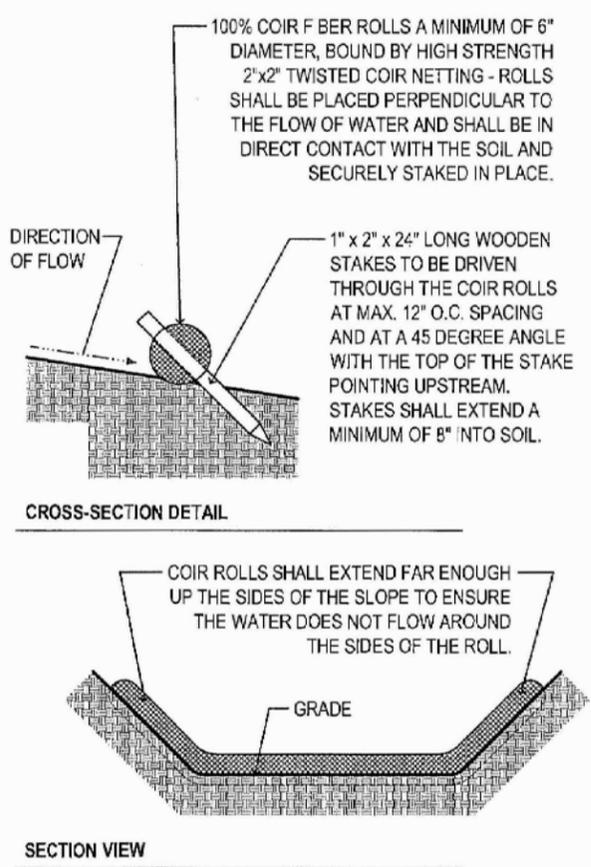

COIR ROLL DETAIL

NOT TO SCALE

3/3

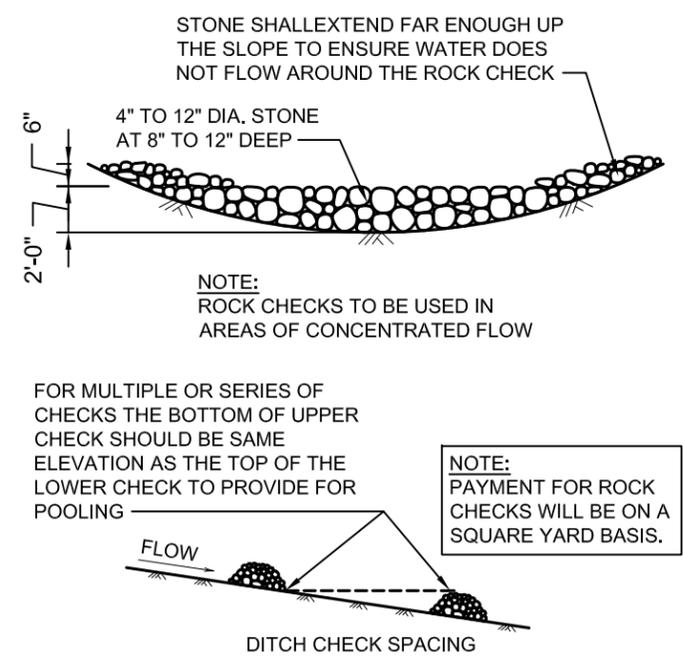

ROCK CHECK DETAIL

NOT TO SCALE

4/3

5.22 Tables And Figures

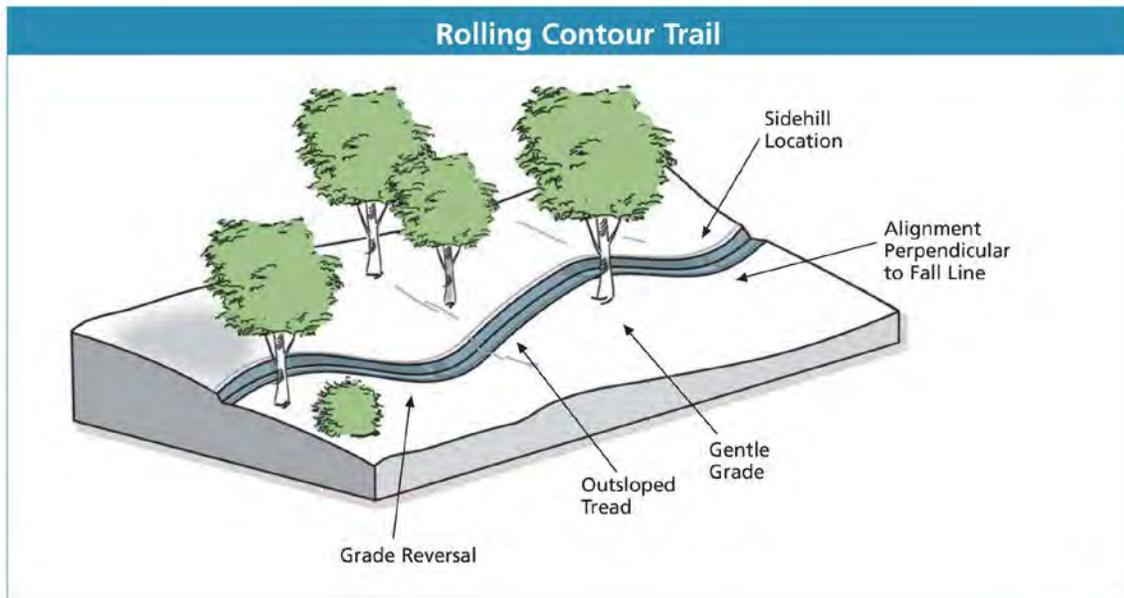

Figure 1: Rolling Contour Trail

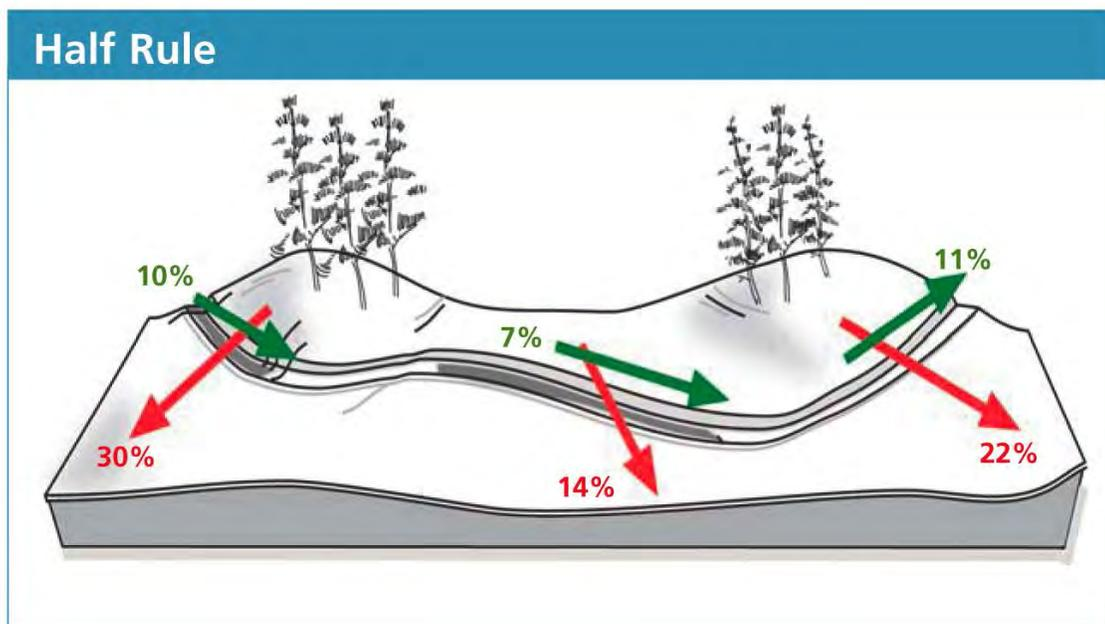
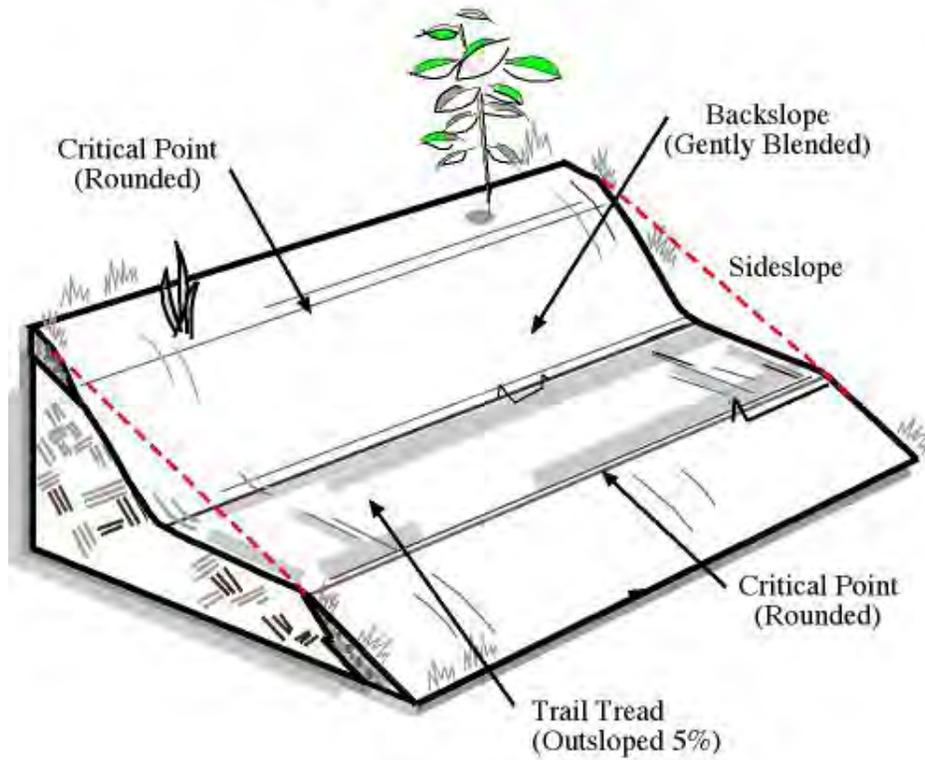

Figure 2: Illustration of The Half Rule

Full Bench Trail



Trail Profile

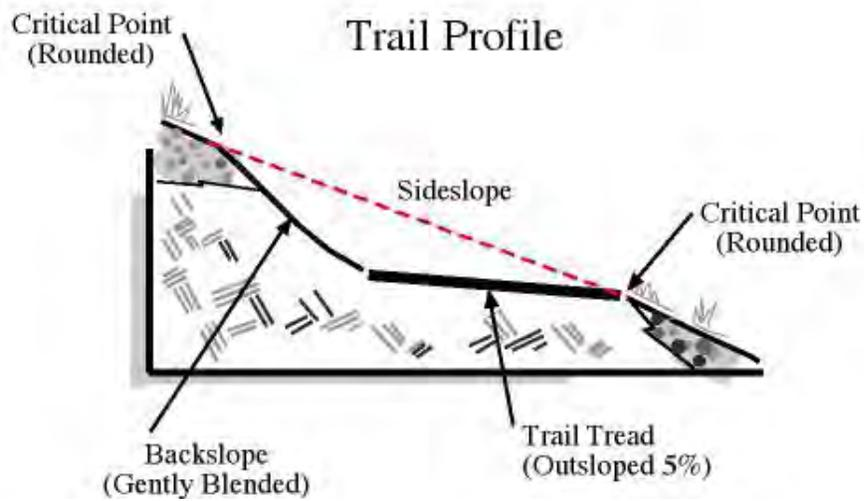

Figure 3: Full Bench Trail

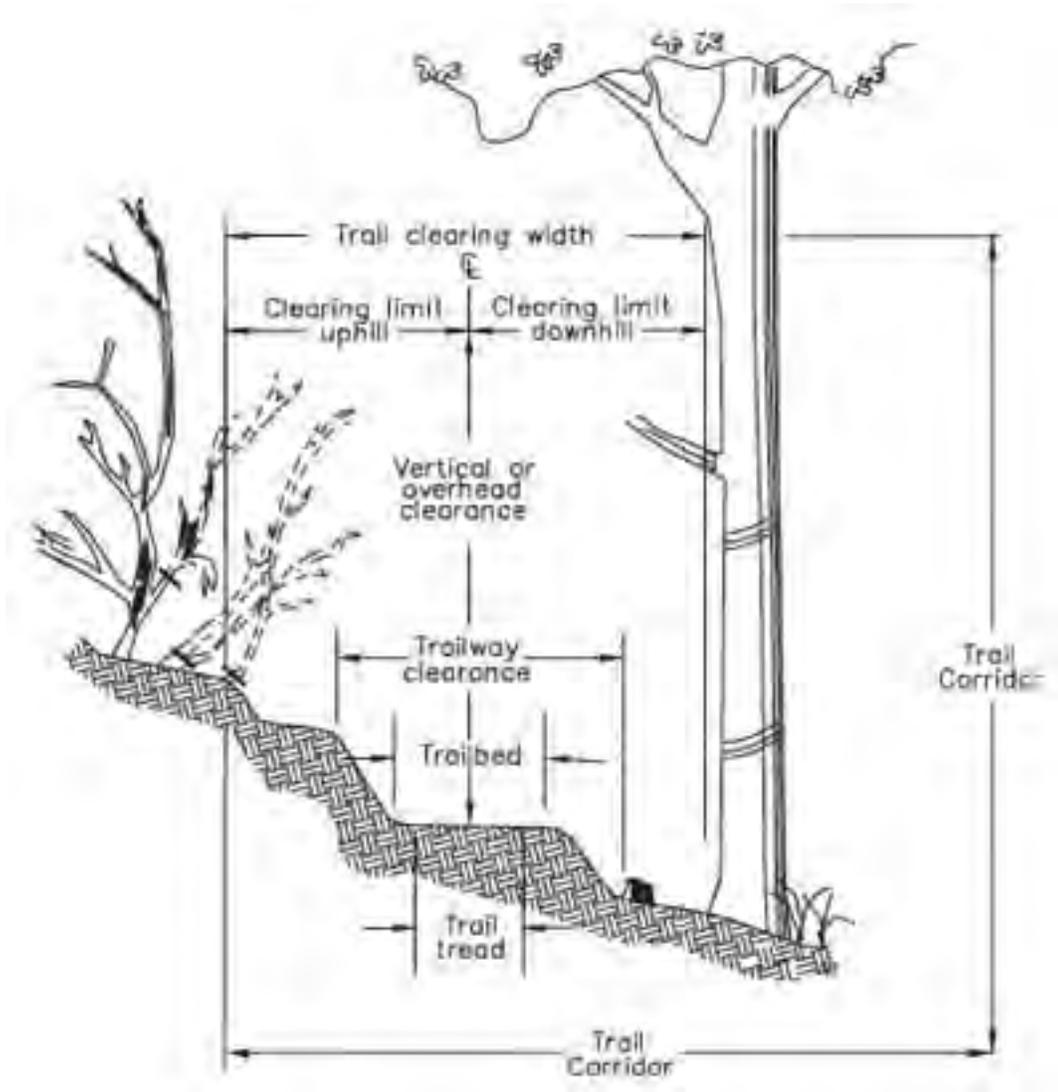
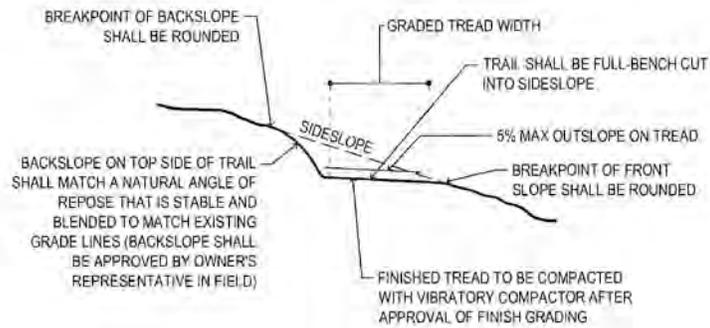
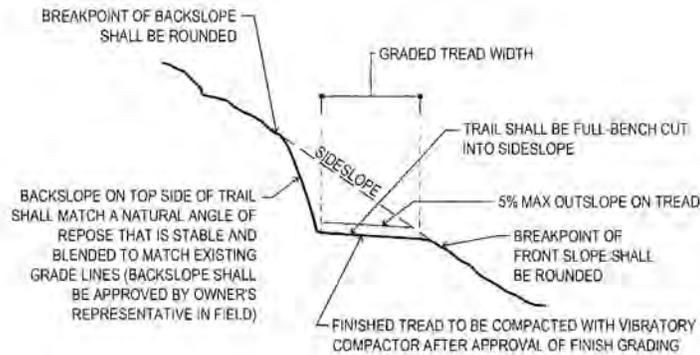

Figure 4: Clearing limits



Type A Type "A" (Low Sideslope Trail) 3%-15% Sideslope



Type "B" (Medium Sideslope Trail) 16%-60% Sideslope

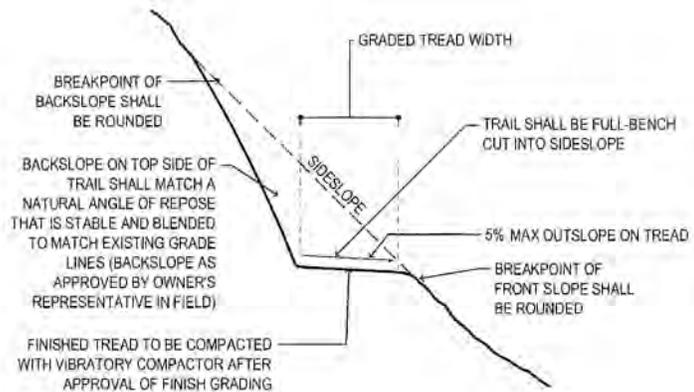

Type "C" (High Sideslope Trail Trail) 61%+ Sideslope

Figure 4.1: Trail Types

Stone Pitching

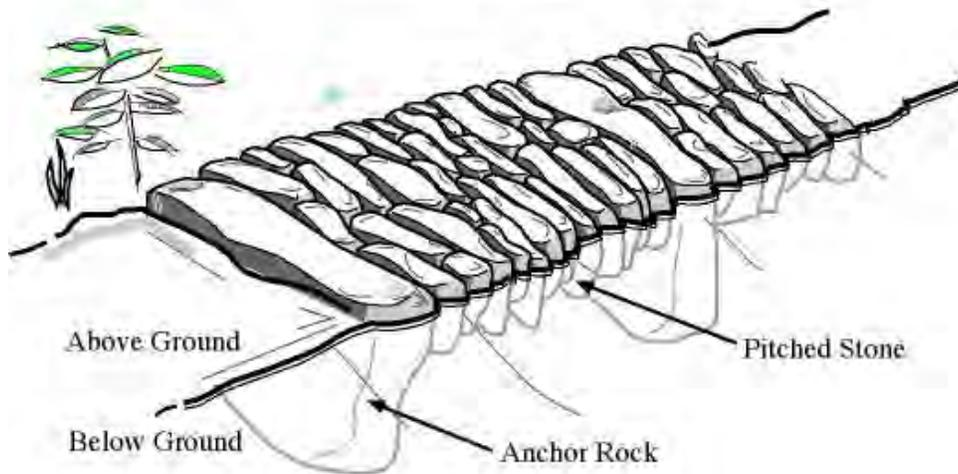

Figure 5: Tread Rock Armoring

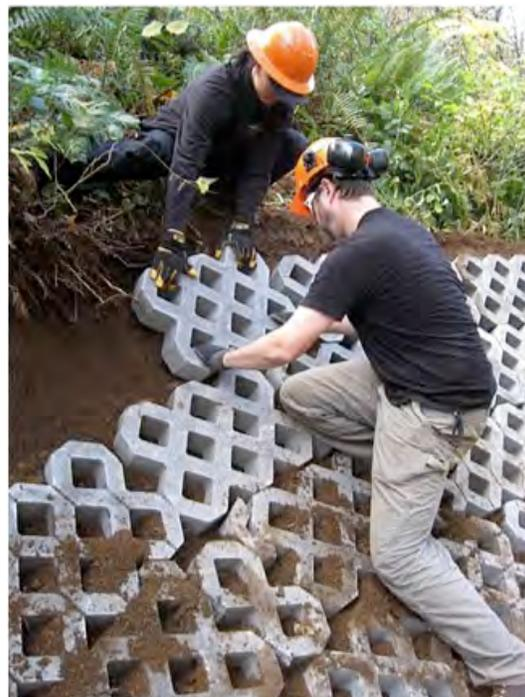

Figure 6: Turf Block Pavers

Rolling Grade Dip

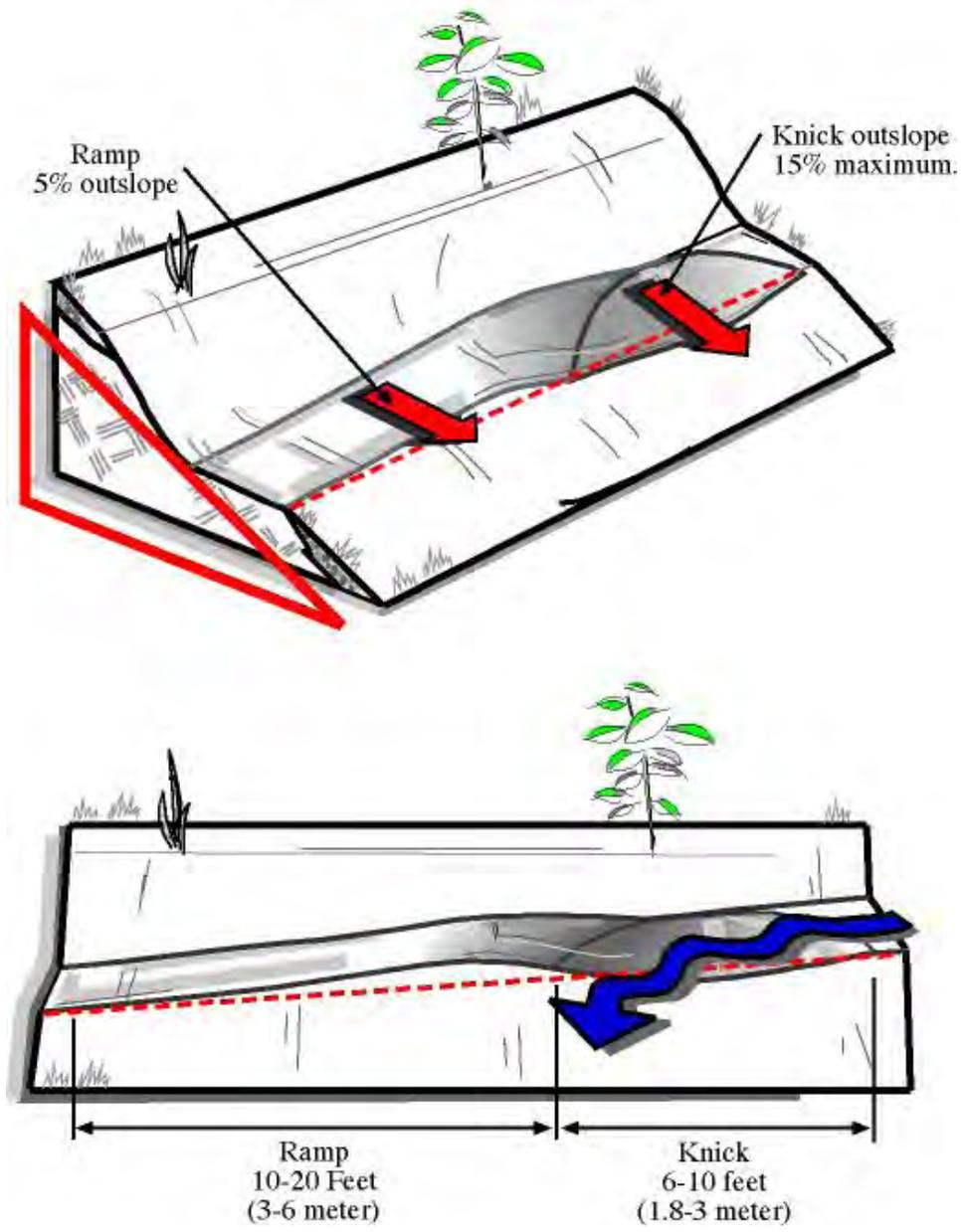

Figure 7: Rolling Grade Dip

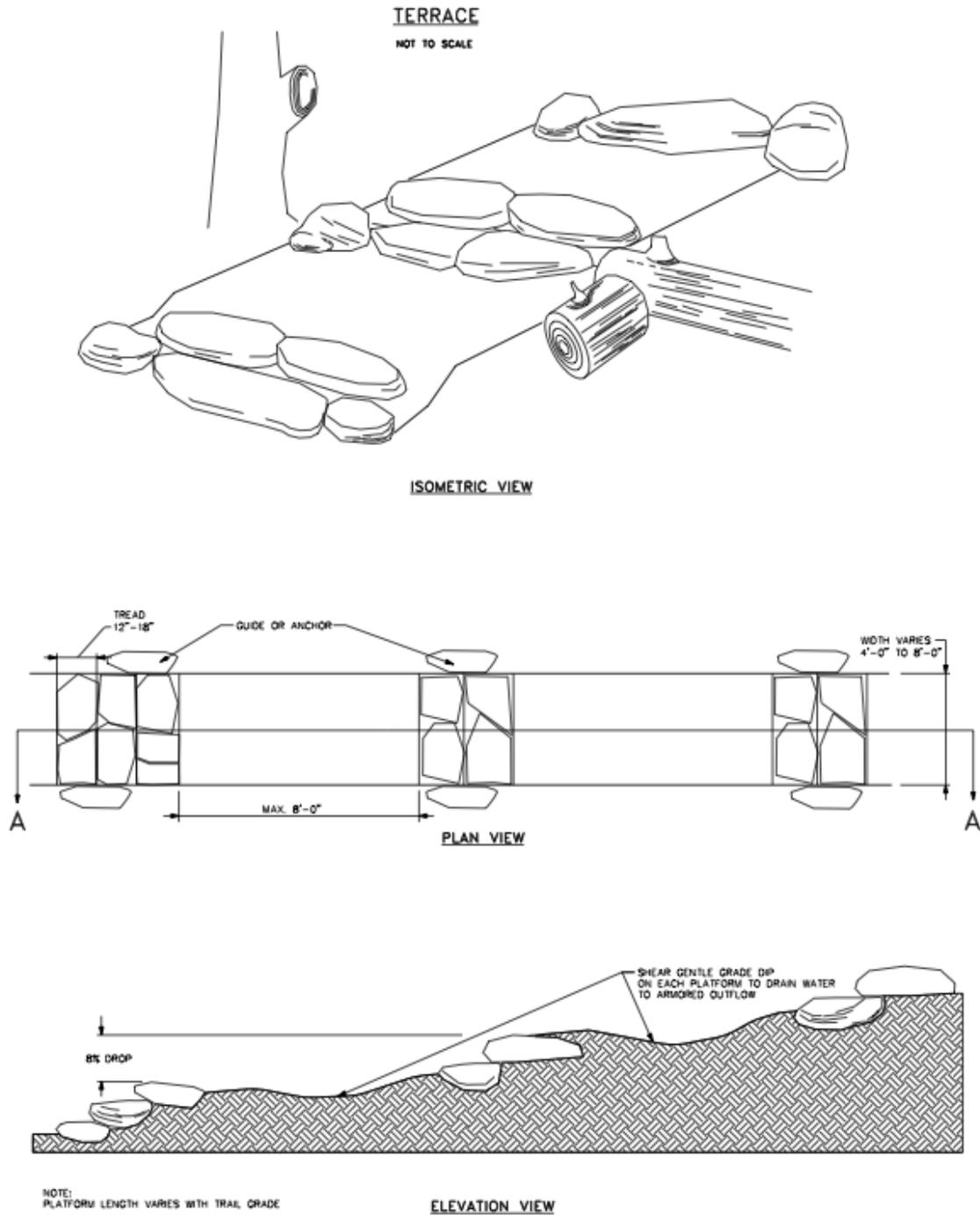

Figure 8: Terrace

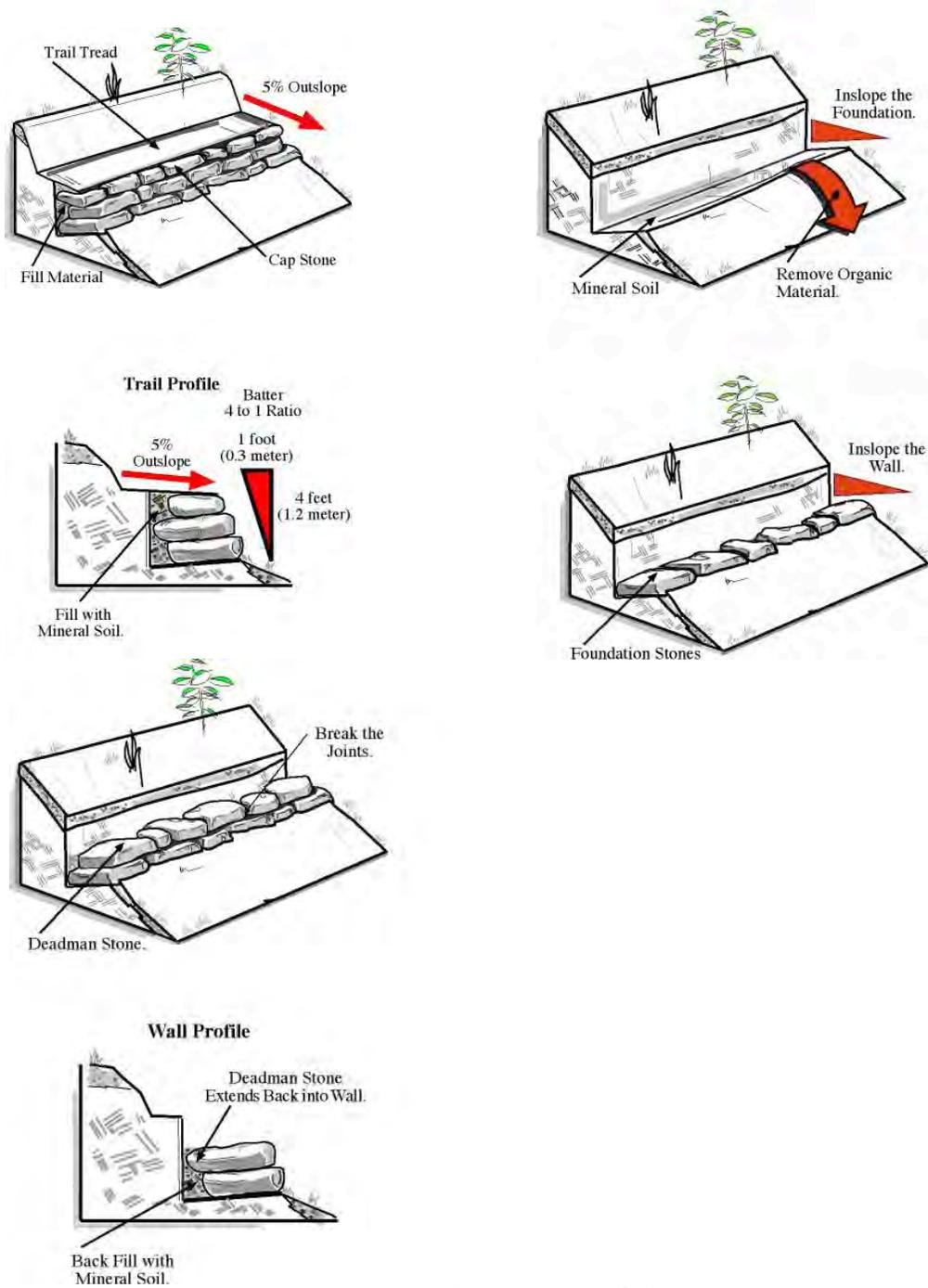

Figure 9: Rock Crib Wall

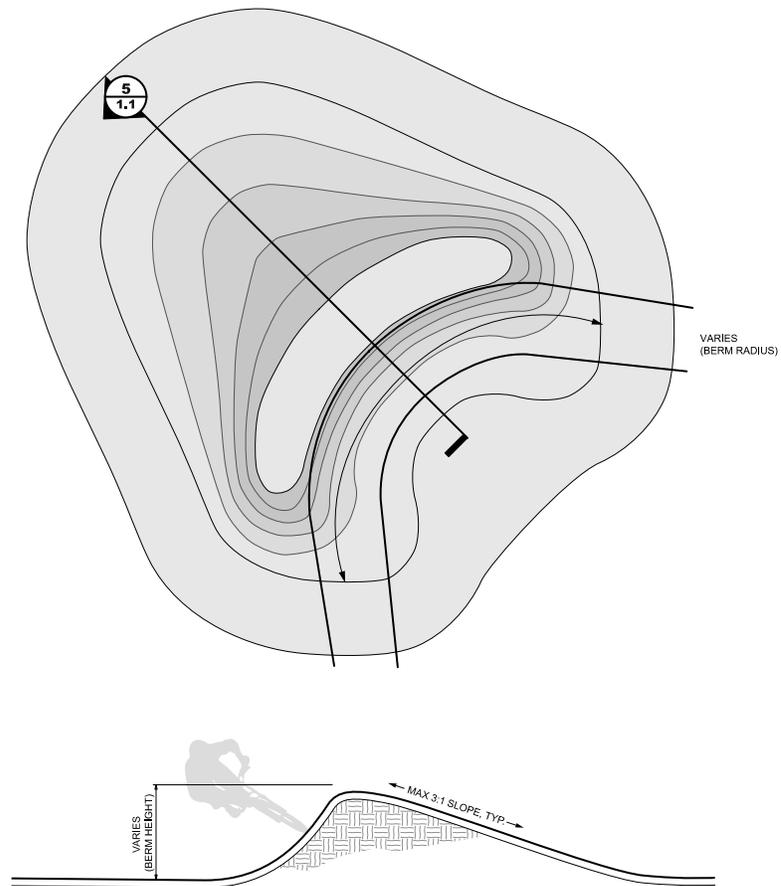

Figure 10: Berm

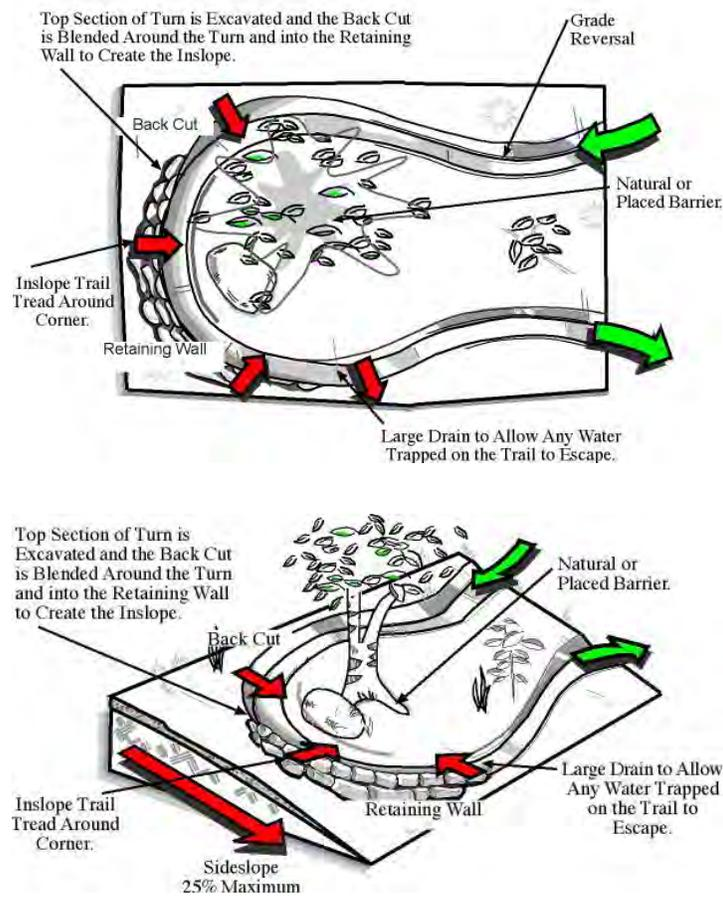

Figure 11: Insloped Switchback (Switchberm)



Figure 12: Technical Trail Feature Boardwalk (TTF)

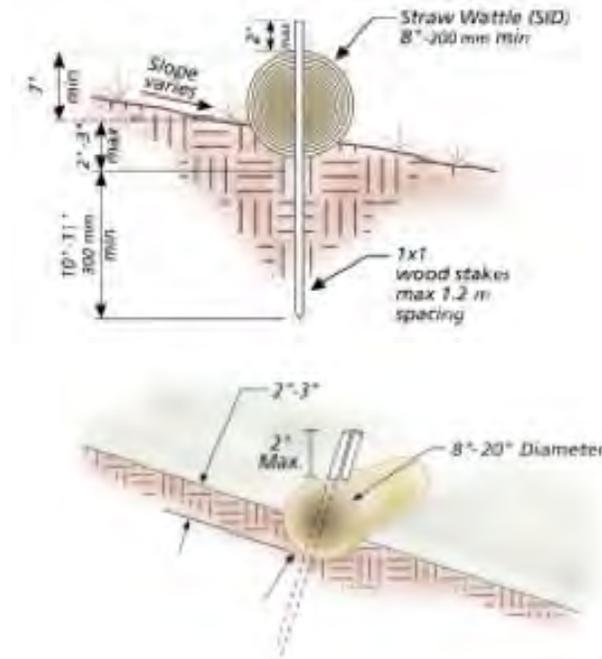

Figure 13: Coir Roll (Bio Log) Installation



Figure 14: Causeway or Turnpike Trail Construction

Trail Closure and Reclamation

Ensure smooth transition
from existing trail to new trail.

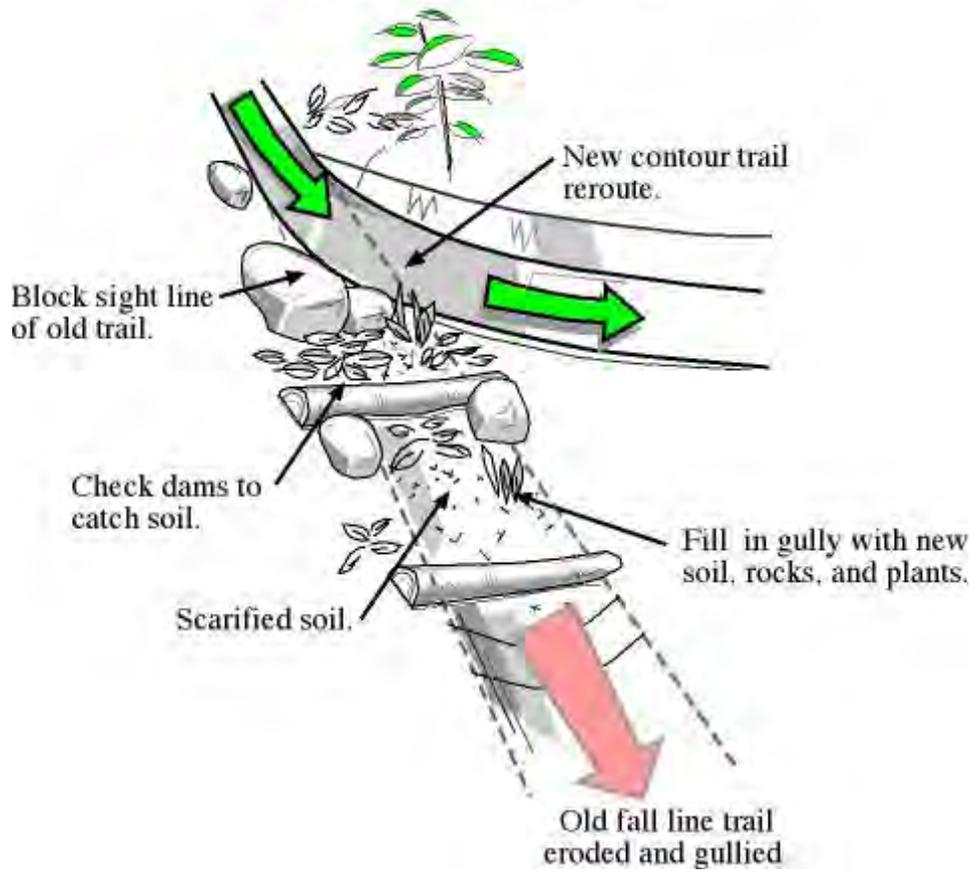

Figure 15: Trail Closure

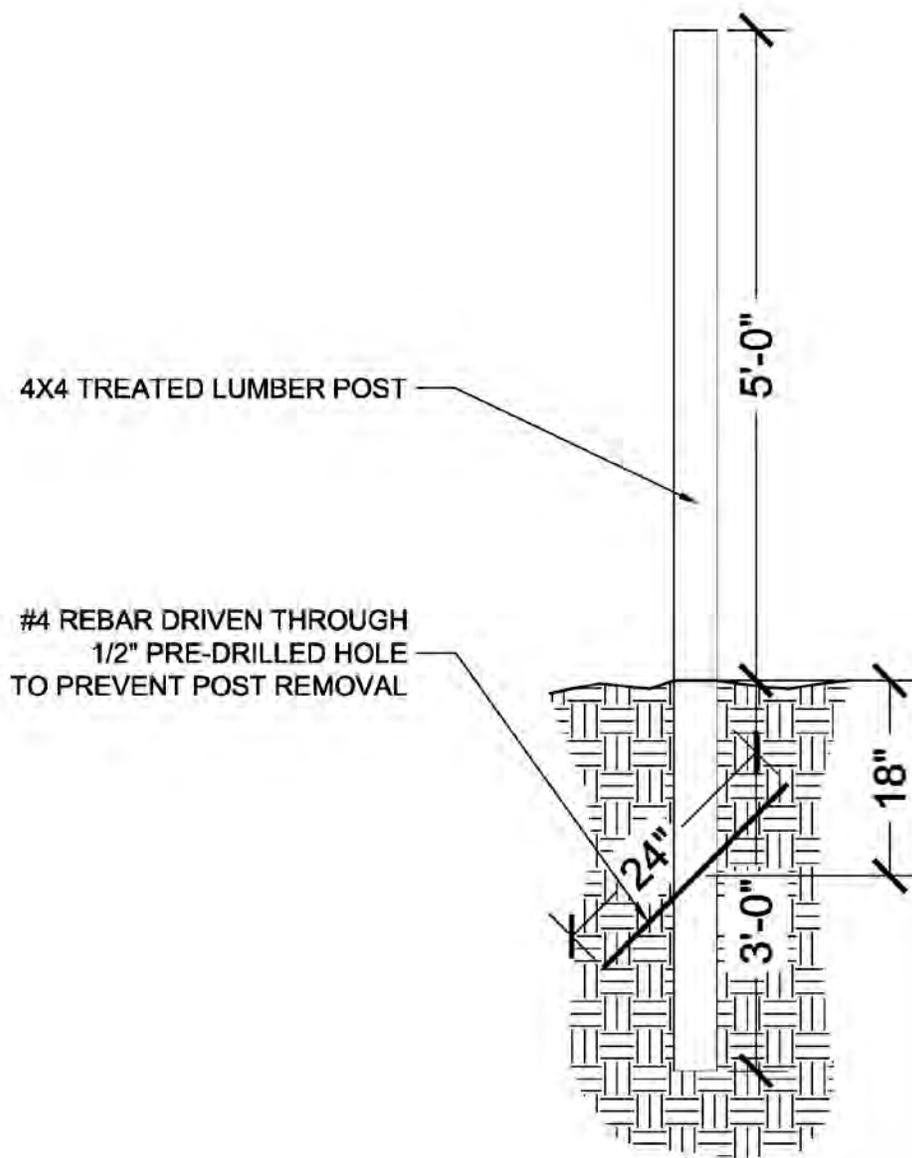

Figure 16: Map Post Installation

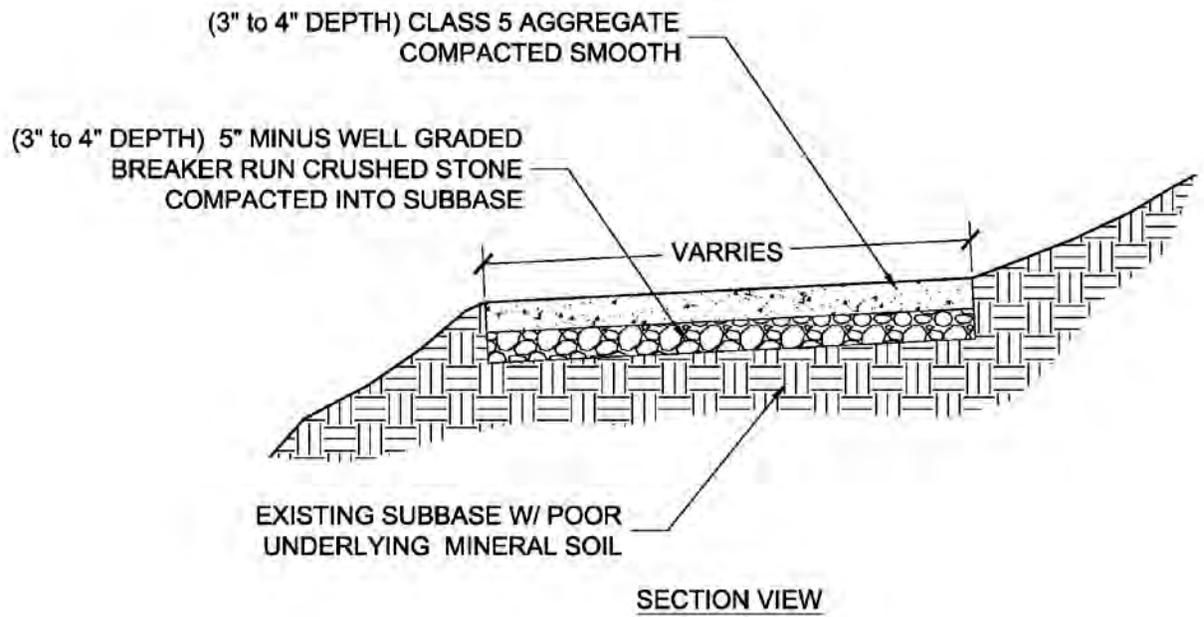

Figure 17: Trail Capping

Appendix C

Lower Nordic Ski Trail Lighting Information

General Notes:
A. BEGIN NOTES HERE.

Keyed Notes: 
1. BEGIN NOTES HERE.

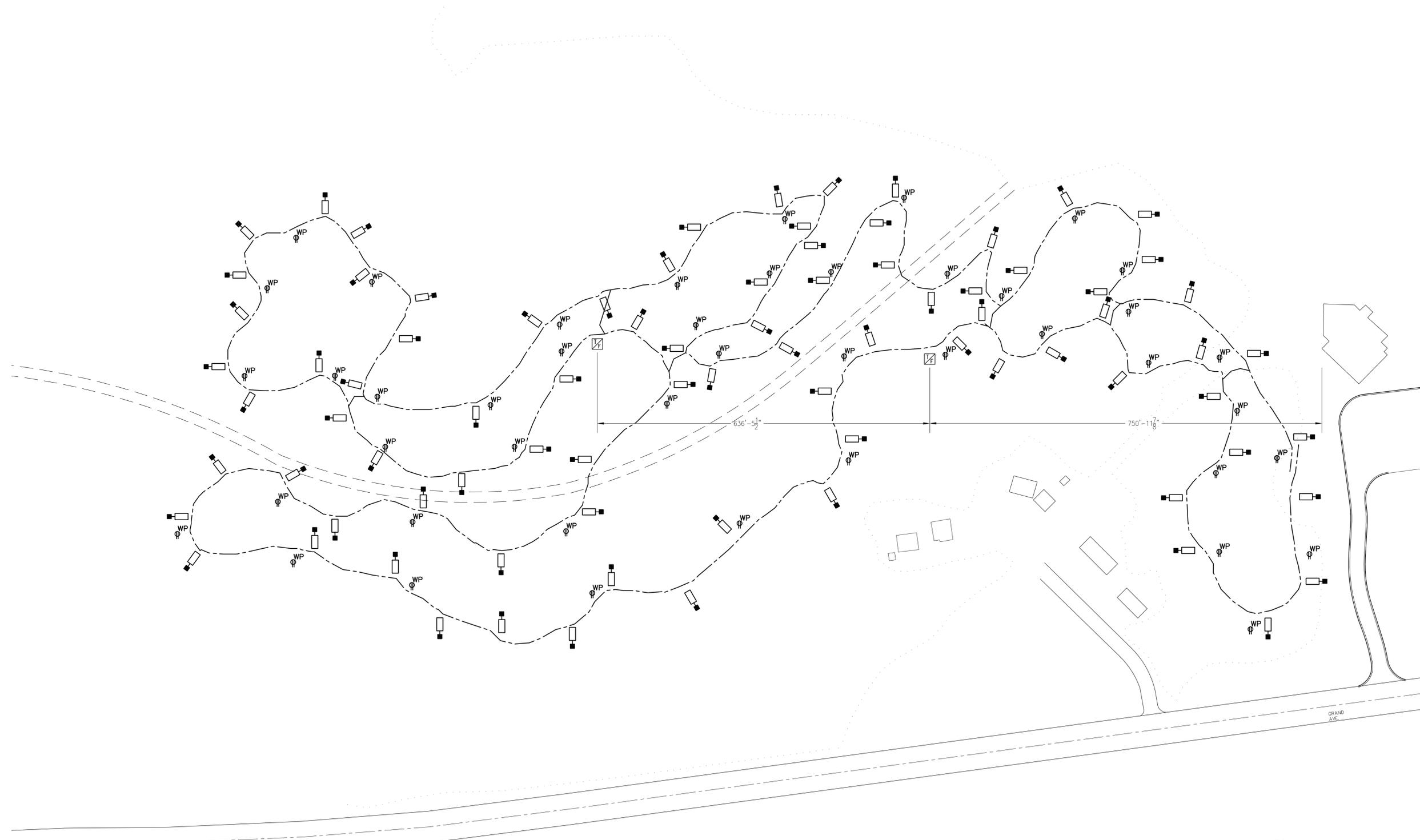

PRELIMINARY
DESIGN/DEVELOPMENT DRAWINGS
NOT FOR CONSTRUCTION



1 LIGHTING LAYOUT PLAN
1" = 100'-0"

S:\S-15001-Spirit Mountain Nordic Trails\1-Design\Drawings\Work\Drawings\S-15001E1.dwg 10/10/2015 2:26 PM NoteA

TORRENT Engineering and Equipment
 P.O. BOX 270 MILFORD, IN 46542 USA
 Phone: (574)-658-3200 Fax: (574)-658-3229 www.torrentee.com

SEH
 PHONE: 218.279.3000
 418 W SUPERIOR ST STE 200
 DULUTH, MN 55802-1512
 www.sehinc.com

FOSTER, JACOBS & JOHNSON, INC.
 345 CANAL PARK DRIVE
 SUITE 200
 DULUTH, MINNESOTA 55802
 218.722.3060
 218.722.1931 fax
 Email: mail@fj.com

Revisions	
No.	Date
0	Date
	Description

PROJECT:
**SPIRIT MOUNTAIN
 NORDIC TRAILS**
 DULUTH, MINNESOTA



SHEET TITLE:
LIGHTING LAYOUT

I hereby certify that this plan, specification or report was prepared by me or under my direct supervision and that I am a duly licensed Professional Engineer under the laws of the State of Minnesota.
R. SCOTT JONES
 Reg. No. 25389 Date: xx/xx/2105

DRAWN BY: NA
 CHECKED BY: RSJ
 PROJECT: S-15001
 LINE IS 1/8" AT FULL SIZE (IF NOT 1"=SCALE ACCORDINGLY)

DRAWING NO:
E1
 Sheet X of X

Appendix D

Lower Nordic Ski Trail Snow Making Noise Analysis

Technical Memorandum

To: Jim Shoberg, City of Duluth
From: Andrew Skoglund
Subject: Spirit Mountain Nordic Center Noise
Date: March 21, 2016
Project: 23691657.00
c: Tom Tri, Barr Engineering

The City of Duluth requested Barr to assess the potential noise impacts of the Spirit Mountain Nordic center expansion, specifically noise from snowmaking and grooming activity at nearby Bessemer Street residences. This memo summarizes the results of that effort.

Executive Summary

To comply with MN state noise standards, snowmaking and grooming at the proposed Nordic center will need to observe some limitations on operation. Grooming and snowmaking activity during daytime hours (7:00 am to 10:00 pm per statute) is expected to be compliant with state noise standards. Grooming and snowmaking during nighttime hours (10:00 pm to 7:00 am per statute) is possible with some operational limitations to maintain compliance with nighttime standards.

Snowmaking and snow grooming sounds are an existing part of the area's noise character from the nearby alpine activity. Given the limited seasonal nature of the snowmaking and snow grooming impacts, overall impact to neighboring residences is expected to be minimal relative to existing activity at Spirit Mountain. Possible mitigation measures could include:

- Siting and orienting snowmaking units such that they can be operated with their sides to the nearest residences
- Use of the Silent PoleCat model for units operating nearest to residences
- Selecting the minimum operating RPM necessary for adequate grooming performance, 1500 rpm or lower if possible.
- Minimizing reverse operations, especially near residences to reduce potential for annoyance

Noise Basics

Noise levels are usually measured in units of decibels (dB). For applications where human hearing is the prime consideration, A-weighting is applied to yield A-weighted decibels (dBA). This weighting serves to better replicate the way the human ear perceives sound. A level of 0 dBA is nominally the threshold of hearing, below which a healthy human ear cannot detect the sound. Most situations never yield levels this low, with a quiet bedroom falling around 40 dBA. A normal conversation is generally in the area of 60 dBA. Decibels are on a logarithmic scale, thus an increase in dB of 10 is perceived as a doubling of noise level. The smallest perceptible change is generally accepted to be 3 dB.

Minnesota noise standards apply at the nearest receptor and are specific to the type of land use at the receptor location. Household units fall under the most stringent Minnesota noise area classification –

NAC 1. Daytime noise levels in an NAC-1 area may not exceed 60 dBA for more than 30 minutes in any given hour (L₅₀) nor exceed 65 dBA for more than six minutes in a given hour (L₁₀). Nighttime noise levels in an NAC-1 area may not exceed 50 dBA for more than 30 minutes in any given hour (L₅₀) nor exceed 55 dBA for more than six minutes in a given hour (L₁₀). (MN Rule 7030.0040).

Table 1. MN Noise Standards

	Day		Night	
	L10	L50	L10	L50
NAC – 1	65	60	55	50
NAC – 2	70	65	70	65
NAC – 3	80	75	80	75
NAC – 4	NA	NA	NA	NA

MN Rules 7030.0040

NAC-1 applies to most residential uses: homes (including farm houses), lodging, designated campgrounds, designated picnic areas, resorts, religious activities, corrections institutions, and more. Any location where people sleep generally falls under this noise classification.

NAC-2 applies to what is generally thought of as commercial areas: retail locations, transportation terminals (air, rail, road, and sea), business offices, government services, parks, recreational areas not designated camping or picnic areas, and similar uses.

NAC-3 applies to industrial type properties: Manufacturing, metals processing, railroads, roads, highway and street right-of-ways, utilities, agricultural and related activities, and all activities not otherwise listed in MN Rule 7030.0050.

NAC-4 applies to undeveloped land, water areas, areas under construction, and other undeveloped land use. These areas have no noise standard, as they are generally unoccupied.

Noise model

The modeled sound levels were projected using ISO 9613 methods for calculating outdoor sound propagation and attenuation in conjunction with manufacturer specifications for attenuation over distance. The modeling assumes wind and weather conditions ideal for sound propagation (e.g. sources upwind of receivers). Actual levels may be lower, with receptors upwind receiving considerably lower levels of noise impact.

Sounds can be divided into various octave bands, a means of grouping different frequencies. The ISO 9613 method allows for modeling impacts depending on octave band. However, octave band data was not available for most of the equipment being assessed. For snowmaking equipment, noise performance data was available across a large range of distances, and was used to calculate projected overall levels.

To: Jim Shoberg, City of Duluth
From: Andrew Skoglund
Subject: Spirit Mountain Nordic Center Noise
Date: March 21, 2016
Page: 3

For modeling of the snow grooming equipment, a more limited range of distances were available, so noise levels were assigned to the frequency band which showed comparable performance to the overall decibel specifications provided by the equipment manufacturers.

Attenuation from vegetation was not included in the modeling calculations. The attenuation values in ISO 9613 are for dense foliage so given the mixed forest and wintertime conditions for this analysis, the effects of vegetation were conservatively not included. Depending on vegetation makeup ranging throughout the area, actual noise conditions may be quieter than those modeled in this evaluation.

Existing noise conditions

Existing noise sources in the area around the project include traffic on Grand Avenue, other local streets, and I-35 to the north; rail traffic to the south; snowmobiles on area trails; Spirit Mountain's existing alpine grooming and snowmaking activity; and grooming activities on the northern Nordic trails. Existing Alpine grooming may operate as near as 180 meters to the Bessemer Street residences. Based on manufacturer specifications, operation of a single PB400 groomer at this distance may yield noise levels ranging up to 67 dBA in the short term. Snowmaking operations in the existing alpine area may vary depending on which alpine run snowmaking is active and how many units are in operation.

Automobile traffic on nearby Grand Avenue is modeled to yield peak passby levels ranging from 58-67 dBA, with truck traffic yielding levels potentially 10 to 15 dB higher. Average traffic rates of 11,500 vehicles per day are expected to result in hourly average noise levels 1 to 6 dB lower than the peak values, depending on traffic volume and composition in a given hour.

New source impact projections

Projected peak levels from the PB100 Nordic groomers at their nearest point to residences (~64m) are 67.5 dBA. Combined noise levels in the case that a PB400 (alpine groomer) and PB100 are both operating at their nearest point to the residences would yield a combined noise level of approximately 70 dBA (two sources at 67 dBA combine to yield 70 dBA). A 3 dB increase in noise levels is generally considered the threshold for which a change in level begins to be perceived. Impacts of this level would be of extremely short duration, as there are few points along the trail where proximity to both the alpine and Nordic groomers can occur. Coordination of grooming operations to minimize concurrent grooming activity at the nearest alpine runs and the Nordic trails may also serve to mitigate this potential peak impact. Alternatively, grooming at these locations could be done simultaneously to minimize the overall duration, with the tradeoff of overall higher levels (though a barely perceptible 3 dB higher) during grooming operations.

Noise levels from the Nordic trail grooming operations are projected to comply with MN state noise standards if some operating limitations are observed. The PB100 has a potential range of travel speeds from 0-14 mph, with most grooming expected to average around 3 mph (5 km/hr). At this rate the entire Nordic trail area would potentially be groomed in approximately 1 hour. If operated at 1800 RPM throughout the Nordic area, the noise level of the PB100 at the nearest residences would potentially rise

To: Jim Shoberg, City of Duluth
From: Andrew Skoglund
Subject: Spirit Mountain Nordic Center Noise
Date: March 21, 2016
Page: 4

higher than the nighttime L_{10} standard. If selected areas are groomed at reduced RPM (1500 RPM), nighttime operation with sound levels below the standards is expected.

Nordic groomer noise levels were modeled based on the expected time series of a groomer passing by at 5 km/hr (~3 mph). The time series analysis evaluated the potential groomer passes, and determined that an individual groomer passby at 1800 RPM would be above the nighttime L_{10} threshold (55 dBA) for about 230 seconds of an individual pass (i.e. when within ~170m of a residence). For operations at 1500 RPM, the distance and associated timing would be 150 seconds over 55 dBA (when within ~120m of a residence). The trails are sufficiently close to the residences that there could be multiple passes within the 170m distance over the course of an hour, exceeding the 6 minute total allowed by the L_{10} standard (10% of the hour). If RPMs are reduced in selected areas, the total time over 55 dBA is reduced enough that the standard can be met (total time for a given residence less than 6 minutes).

Based on the distances determined from the time series analysis, buffers from the nearby residences were developed to show where groomer levels could exceed 55 dBA (@ 1800RPM = 170m) and then filtered that based on total trail distance within each residence's buffer. For trail length less than 500m, the total grooming time with levels above the threshold would be less than 6minutes (assuming a 5 km/hr grooming speed), and no limitation is needed. For Trail/Receptor combinations at 1800RPM with lengths above 500m (Residences 1-4, 13) the smaller buffer distance for 1500RPM operation (120m) was evaluated and trail lengths within that reduced zone were less than 500m (6 minutes) each, so operation in that area at the reduced RPM/noise level would comply with the nighttime standard.

The modeled limitations on compliant nighttime grooming can be summarized as limiting grooming within 120m of a given residence to 6 minutes in an hour, and if operating at 1800RPM extending the buffer distance to 170m.

Noise levels from snowmaking assuming all 44 standpipe locations in operation concurrently range from 50 to 57 dBA depending on residence. Levels in this range are projected to be compliant with daytime noise standards. However, only six units are proposed for regular snowmaking operations. Operating only six Nordic snowmakers is expected to reduce impacts to levels below the nighttime standards as well, generally ranging from 40 to 50 dBA depending on configuration. Several potential configurations have been modeled, and associated placement limitations have been developed. The attached Figure 1 highlights which snowmaking locations near homes would need to be limited to the Silent PoleCat models to maintain compliance with nighttime standards. Various operating configurations may be possible to limit or tailor impacts as balanced by particular operational needs. Given the proximity to Grand Avenue, existing background noise in the Bessemer Street area may yield levels already above the projected Nordic center contribution, with little additional noise impact due to snowmaking and grooming activities at the Nordic center.

Residences to the northeast are expected to experience little to no impact from the project, as the alpine area activity is both closer and more extensive than the proposed Nordic operations. The new Nordic center is not expected to be discernably different from existing operations for residences to the northeast.

To: Jim Shoberg, City of Duluth
From: Andrew Skoglund
Subject: Spirit Mountain Nordic Center Noise
Date: March 21, 2016
Page: 5

Vegetation clearing

The clearing of vegetation for the creation of the trail is expected to have minimal effect on noise transmission from the existing operations. Given the elevation difference from much of the alpine area versus the nearby residences, the potential sound reducing path through existing vegetation is limited. Vegetation generally provides 0.1 dB or less reduction per meter of depth. Since the trail corridors are expected to be approximately 9 meters, removal of this vegetation is not expected to significantly alter the existing noise levels, even if it were completely within the sound path from sources higher on the mountain. Intervening vegetation may be reduced by as much as 18 meters, given the two passes of trail between the properties and the existing alpine area. Clearing of the Nordic trails is expected to have minimal effect on existing noise levels.

Mitigation Options

Snowmaking

Equipment Orientation

Specifications from the manufacturer indicate that noise levels to the sides of the units are lower than to the front or rear of the unit. Siting and orienting units such that they can be operated with their sides to the nearest residences will aid in minimizing the potential impacts. While the distribution and orientation of the trails versus the residences does not allow all units to be perfectly aligned for all residences, efforts should be made to minimize the number of units oriented directly toward or away from residences. There may be some additional reduction available from erecting partial enclosures or barriers adjacent to the snowmaking units, blocking the direct path of noise from the units toward residences. However this is generally not as practical for mobile units.

Equipment Selection

Use of the Silent PoleCat model on units operating nearest to residences will yield lower noise impacts than other models of snowmaker identified as candidates for the project (Kid PoleCat, Super PoleCat). This mitigation is reflected in the modeled impacts evaluation (Figure 1 - Locations 1-14), and is expected for implementation at the Nordic center.

Operating hours

Nordic snowmaking operations during statutory daytime (7am to 10 pm) are expected to maintain compliance with state standards regardless of configuration, as the daytime standards are 10 dB higher. Limiting the snowmaking to Silent PoleCats or their equivalent on trails nearest residences is expected to be sufficient for demonstrating compliance with nighttime standards. Given that some additional attenuation may be provided by the mixed vegetation (deciduous and coniferous) between the trails and the residences, actual levels may be lower than those modeled.

To: Jim Shoberg, City of Duluth
From: Andrew Skoglund
Subject: Spirit Mountain Nordic Center Noise
Date: March 21, 2016
Page: 6

Grooming

Equipment selection and settings

It is understood that the grooming equipment to be used has already been selected, a PistenBully 100 with Tier 3 engine. Noise levels from the unit are specified by the manufacturer to be approximately 3 dB lower when operated at 1500 RPM instead of 1800 RPM. Selecting the minimum operating RPM necessary for adequate grooming performance will aid in minimizing noise impacts from the groomer. Additionally if other muffler options are available for the grooming equipment, the reduction in noise level could be equivalent and may avoid the need to limit operating RPM in select areas.

Given the short expected duration of reversing relative to overall operation, backup alarms are not expected to be subject to the state standards. However, minimizing reverse operations, especially near residences will serve to reduce potential for annoyance. If reversing alarms are found to be a nuisance, several options may be available to reduce their impacts. Self-adjusting backup alarms can be installed which vary their emitted noise level depending on background noise level, minimizing excess noise generation. Additionally 'white noise' or broadband reverse alarms may be another option to reduce annoyance, though testing to determine whether they remain safely audible when operated in conjunction with snowmaking equipment is recommended if this option is pursued.

Operating hours

Operation of the grooming equipment is expected to be compliant with state noise standards throughout the daytime hours for all proposed operating scenarios. Peak levels may exceed threshold levels at times, but not of a sufficient duration to result in non-compliance with standards. Compliant operation during nighttime hours is expected with limitations on operating RPM in certain areas and minimization of activity on portions of the trail adjacent to residences.

Operating duration

As noted in the impact discussion, it is expected that routine grooming of the Nordic trails may be possible in less than one hour. This will limit the effect of the grooming on L₅₀ standard compliance, and short duration passes near homes will also aid in maintaining compliance with L₁₀ standards.

Vegetative screening

Noise attenuation provided by vegetation is generally limited, especially in the relatively short distances involved in this analysis. Vegetation generally is modeled to attenuate approximately 0.02 to 0.1 dB per meter of dense foliage, depending on the frequency of the noise involved. Vegetation less than 10m as a rule of thumb is not expected to provide measurable reduction in noise level. There do not appear to be any areas where additional vegetation could be added of a sufficient depth or density to meaningfully affect measured noise levels. There may be ancillary benefits to adding additional vegetative screening (e.g. light shielding effects), but it is not expected to significantly affect measured noise levels.

Barr Footer: ArcGIS 10.3.1, 2016-03-21 12:48 File: I:\Projects\23169\1657 Spirit Mountain\Maps\Reports\Noise_Memo_Fig1_Layout_and_Limits_Map_21MAR2016.mxd User: ajs

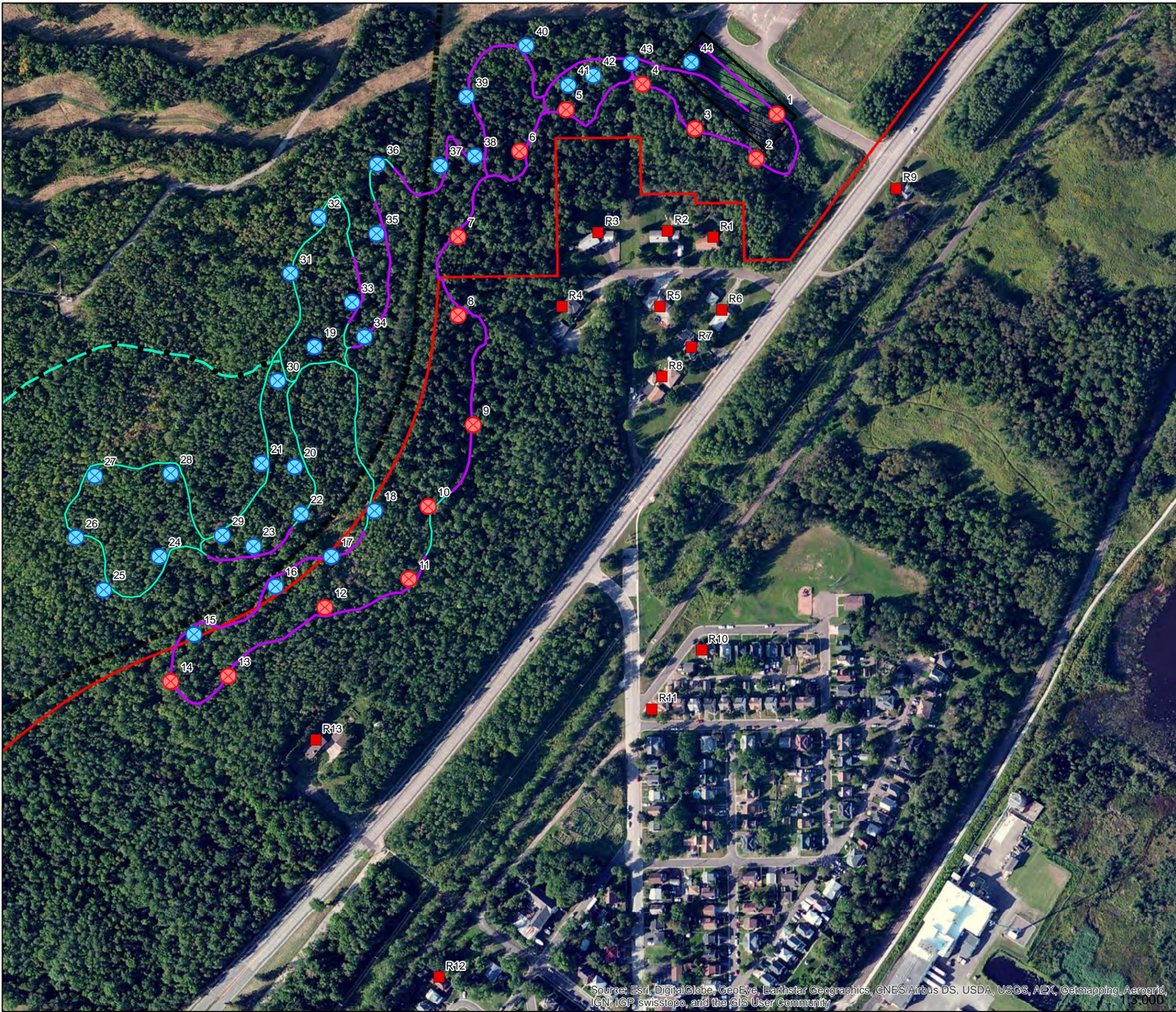

- Snowmaking Equipment
- Snowmaking - Silent Only
- Selected Residential Receptors
- Spirit Mountain Boundary
- Staging Area
- Proposed Trails
 - Nordic Ski , Connector
 - Nordic Ski , Lower
 - 1500 RPM Grooming Limit Trails
- Existing Trails
 - DWP Multipurpose Trail

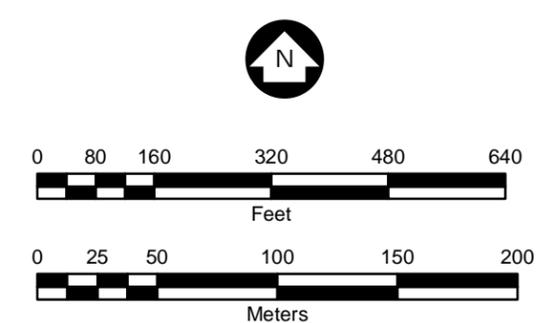

Figure 1
 NOISE MODELING LAYOUT AND LIMITS
 Proposed Improvements - Nordic Ski Trails
 Spirit Mountain Recreation Area
 City of Duluth
 St. Louis County, Minnesota

Source: Esri, DigitalGlobe, GeoEye, Earthstar Geographics, CNES/Airbus DS, USDA, USGS, AEX, Getmapping, Aerogrid, IGN, IGP, swisstopo, and the GIS User Community 1:3,000

Appendix E

Bessemer Street Drainage Analysis



Building a Better World
for All of Us®

MEMORANDUM

TO: Jim Shoberg
City of Duluth

FROM: Emily K. Erdahl
Matt Bolf

DATE: January 6, 2016

RE: Bessemer Street Drainage
SEH No. FOSJJ 133194

The purpose of this memo is to summarize the preliminary analysis of the potential effects caused by adding a portion of a proposed cross country ski trail within the drainage area of the Bessemer Street residential area. Bessemer Street is a residential area located off of Grand Avenue, south east of Spirit Mountain ski area in Duluth, Minnesota. An abandoned DWP Rail Line exists in between the Spirit Mountain ski area and the Bessemer Street residential area. The City is proposing a new 11,000 foot long cross country ski trail that would run adjacent to the abandoned DWP Rail Line, a portion of which would run through the drainage area of the Bessemer Street residential area.

The Bessemer Street drainage area was delineated using MnTOPO and St. Louis County Contours and structure maps provided by the City of Duluth. A drainage area is an area of land that drains to a common point, in this case, the Bessemer Street residential area. The delineation of this watershed included identifying high points or ridgelines on either side of the study area and subsequently connecting these areas by perpendicularly following topography to create a drainage area boundary. Boundaries of the drainage area to the Bessemer Street residential area include a slight ridge to the south adjacent to the 85th Ave W Creek, the DWP Rail Line to the west of the residential area, and a high ridge to the northeast adjacent to the 84th Ave W Creek, yielding an area of 6.65 acres. The 84th and 85th Ave W Creeks flow through culverts under the DWP Rail Line, past the Bessemer Street residential area on the north and south sides respectively, and again through culverts under Grand Avenue, ultimately discharging to the St. Louis River.

Approximately 445 feet of the proposed trail will run through the Bessemer Street residential drainage area. The trail will be 24 feet wide and include 3 feet of snow pack, adding at most an additional 32,040 cubic feet of snow to the residential area. In comparison, the average annual snowfall in Duluth, Minnesota is 86.1 inches, or 2,076,740.3 cubic feet total in the Bessemer Street drainage area. The ratio of added snowpack to the average annual snowfall is at most 0.015:1, or 1.5% increase. It should be noted that the amount of snow making required for the trail will be dependent on the natural snowfall received. A year with sufficient snowfall will require no or little additional volume of snow. Only during years with low snowfall will the trail require the full amount of additional volume of snow.

Due to low ratio of proposed trail area to the overall drainage area, any additional runoff generated from snow pack of the cross country ski trail will be negligible to the Bessemer Street residential area. It should be noted that the DWP Rail Line has a ditch system on the west side which diverts the natural drainage patterns away from the Bessemer Street residential area to culverts on either side of the Bessemer Street residential area.

Bessemer Street has an existing storm sewer system that includes a rock swale, inlet, catch basins and manholes which discharge northeast of the residential area to a culvert carrying water under Grand Avenue and to the southeast, ultimately ending up in the St. Louis River. The storm sewer system was not reviewed for capacity. Culverts under the DWP Rain Line and Grand Avenue that carry flow of the 84th and 85th Ave W Creeks were not assessed for capacity or backwater effects to the Bessemer Street residential area.

A site visit was made to Bessemer Street and it was determined that there are room for improvements to the Bessemer Street storm sewer that will improve drainage patterns and reduce sheet flow through the Bessemer Street residential lots. Improvements could include extending and widening the rock swale away from homes to capture drainage prior to reaching the residential area, adding a flared end section to the end of the rock swale, and evaluating the Bessemer Street storm sewer system and the 84th and 85th Ave W culverts for capacity and making additional improvements on an as needed basis.

Exhibit 1 shows the Bessemer Street drainage area, proposed cross country ski trail, and existing storm sewer system. Exhibit 2 shows areas of potential improvements to the Bessemer Street drainage.

EKE

S:\V\F\OSJ\133194\5-final-dgn\51-drawings\10-Civil\cad\dwg\pre-project\drainage_areas.dwg 1/5/2016 12:59 PM seerdahl

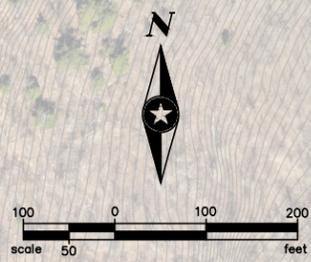
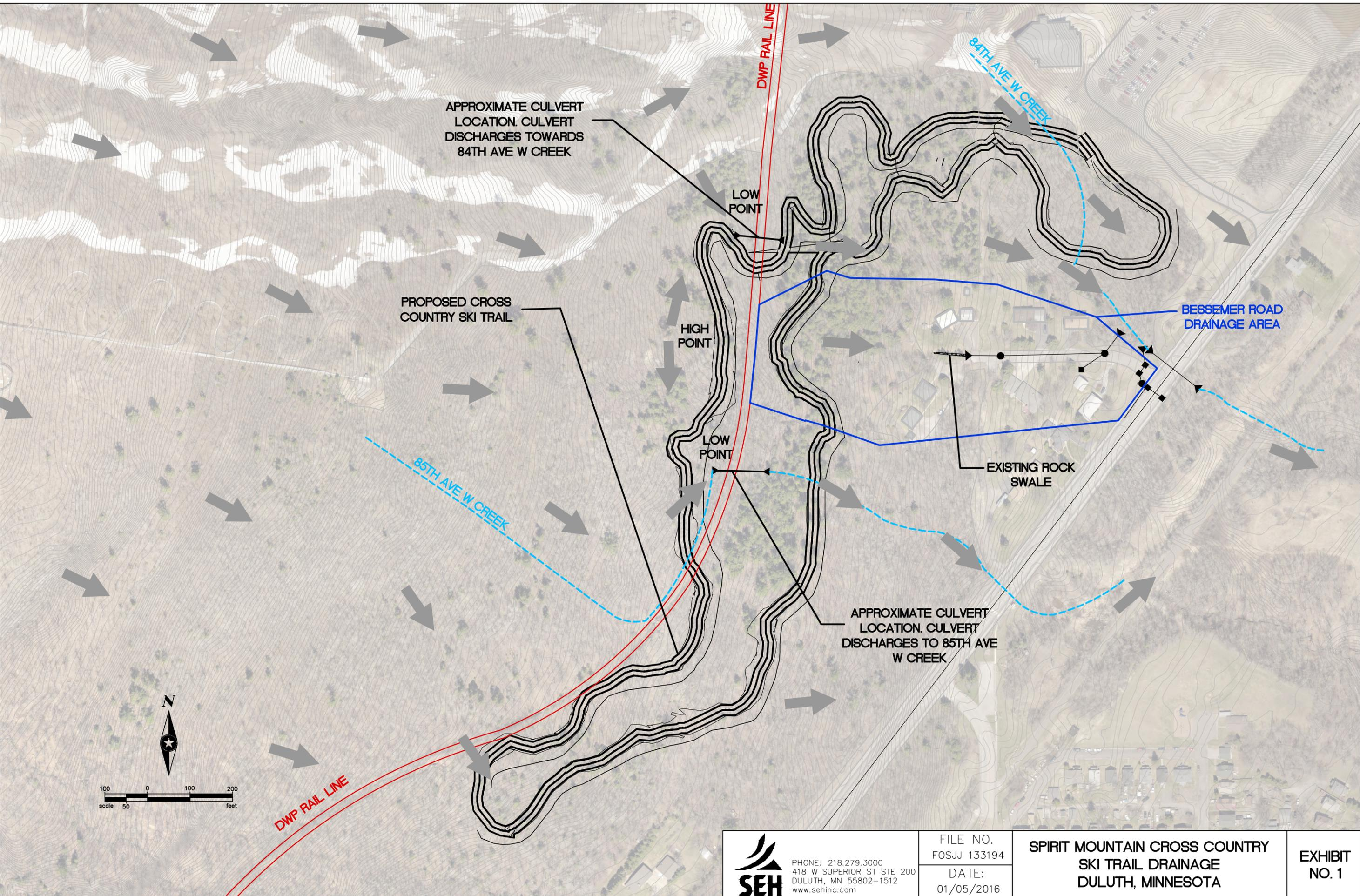

 PHONE: 218.279.3000 418 W SUPERIOR ST STE 200 DULUTH, MN 55802-1512 www.sehinc.com	FILE NO. FOSJJ 133194	SPIRIT MOUNTAIN CROSS COUNTRY SKI TRAIL DRAINAGE DULUTH, MINNESOTA	EXHIBIT NO. 1
	DATE: 01/05/2016		

S:\V\FOSJ\133194\5-final-dgn\51-drawings\10-Civil\cad\dwg\potential drainage improvements.dwg 1/4/2016 4:10 PM eerdahl



EXTEND ROCK SWALE TO CAPTURE DRAINAGE FROM FLOWING OVERLAND TO THE RESIDENTIAL AREA

INSTALL FLARED END SECTION TO MORE EFFICIENTLY CAPTURE DRAINAGE

WIDEN AND CLEAN OUT EXISTING ROCK SWALE TO MORE EFFICIENTLY CAPTURE DRAINAGE

EVALUATE EXISTING STORM SEWER SYSTEM FOR CAPACITY



PHONE: 218.279.3000
418 W SUPERIOR ST STE 200
DULUTH, MN 55802-1512
www.sehinc.com

FILE NO.
FOSJJ 133194

DATE:
01/04/2016

**BESSEMER ROAD RESIDENTIAL AREA
POTENTIAL DRAINAGE IMPROVEMENTS
DULUTH, MINNESOTA**

**EXHIBIT
NO. 2**





